



Jaguar X-Type Driver's Handbook

JAGUAR CARS LIMITED, as manufacturers, are dedicated to the design and production of vehicles which meet the expectations of the world's most discerning purchasers.

To complement the features, systems and technology of your new vehicle we have produced this Driver's Handbook. In it we have undertaken to make the control of complex systems easy to understand and operate.

The information contained herein applies to a range of vehicles and not to a specific vehicle. For the specification of a particular vehicle, owners should consult their Jaguar Dealer.

The Manufacturer reserves the right to vary its specifications with or without notice, and at such times and in such manner as it thinks fit. Major as well as minor changes may be involved in accordance with the Manufacturer's policy of constant product improvement.

All rights reserved. No part of this publication may be reproduced, stored in a retrieval system or transmitted, in any form, electronic, mechanical, photocopying, recording or other means without prior written permission from the Service Division of Jaguar Cars Limited.

Contents

1. Owner information

General information	1-1
Warnings, Cautions and Notes	1-2
Health and safety	1-3
Regular servicing	1-4
Jaguar diagnostic system	1-4
Vehicle identification	1-4
Protect the environment	1-5
Mobile/portable telephones	1-5
Window tinting	1-5
Touch-screen display	1-6
Jaguar Telematics	1-9
Before using the system	1-9

2. Security and locks

Ignition switch	2-1
Vehicle security	2-2
Key transmitter	2-3
Door locks and handles	2-5
Vehicle locking and unlocking	2-5
Child safety locks	2-7
Alarms and audible signals	2-9
Security features	2-10
Radio frequency approval	2-11
HomeLink® Universal Transceiver	2-12

3. Before driving

Occupant protection	3-1
Seat adjustment	3-12
Steering column adjustment	3-15
Door window operation	3-16
Window anti-trap feature	3-17
Mirrors	3-17
Luggage compartment	3-20

4. On the road

Instruments	4-1
Warning lights	4-2
Audible warnings	4-8
Message centre	4-9
Messages	4-10
Trip computer	4-13
Cruise (speed) control	4-16
Exterior lighting	4-18
Interior lighting	4-21
Reverse park control	4-23
Sunroof	4-24
Wipers and washers	4-25
Handbrake	4-27
Horn	4-27

4. On the road (continued)

Interior features	4-28
Sun visors and vanity mirrors	4-30
Cigar lighter and ashtray	4-30
Rear centre armrest	4-30
Glove compartment	4-31
Rear sun blind	4-32
Starting/stopping the vehicle	4-33
Automatic transmission	4-35
Gear-shift interlock	4-35
Gear selector positions	4-35
Sport mode	4-37
Manual transmission	4-37
Anti-lock braking system(ABS)	4-38
Dynamic stability control(DSC)	4-40
General driving information	4-41
Winter driving	4-42
Touring	4-43
Towing a caravan or trailer	4-44
Fuel and refuelling	4-45

5. Climate control

Introduction	5-1
Manual climate control	5-4
Automatic climate control with LCD screen	5-7
Automatic climate control with touch screen	5-11

6. Roadside emergency

Inertia switch	6-1
Emergency starting	6-2
Wheel changing and jacking	6-4
Vehicle recovery	6-9
Transporting	6-10
Bulb renewal	6-12
Fuses and fuse boxes	6-16
Fuse box locations	6-17

7. Maintenance

General maintenance	7-1
Bonnet release	7-3
Regular checks	7-4
Checking and replenishment	7-6
Battery	7-14
Windscreen wipers	7-17
Tyres	7-18
Tyre pressures	7-18
Vehicle care	7-21
Interior care	7-21
Exterior care	7-22
Electrical accessories	7-24

Contents

8. Specifications

Vehicle data	8-1
Weights (average/approximate)	8-2
Roof-rack capacity and trailer weights	8-3
Dimensions	8-4
Wheels and tyres	8-5
Tow-bar fixing points	8-6

A comprehensive index is located at the back of this Handbook.

General information

Whether you are new to the Jaguar marque or have previously owned Jaguar or Daimler vehicles, we are pleased that you have made Jaguar your choice of vehicle this time.

For safety and the pleasure you will get from your new vehicle, please take the time to get well acquainted with your vehicle by reading the handbooks.

Details of the vehicle warranty are contained within the 'Total Care Handbook' for UK markets and the 'Service Record and Warranty Book' for all other markets.

When left-hand or right-hand is used in the text, this refers to the left-hand side or right-hand side of the vehicle, viewed from the rear.

This Handbook describes every option and model variant available and therefore some of the items covered may not apply to your particular vehicle.

Jaguar Dealers

Jaguar Dealers are chosen with care. Each is dedicated to providing a Sales, Service and Spare Parts facility of the highest standard.

Jaguar Dealers are provided with full technical support from the factory, with comprehensive training for all their technicians. Dealers' workshops operate to a high standard and have all the necessary tools and equipment essential to maintain or repair Jaguar vehicles.

A current list of Dealers is included in the vehicle literature pack.

Genuine Jaguar parts and accessories

Your Jaguar Dealer can supply you with genuine replacement parts and accessories which are fully approved to Jaguar's original equipment specification. This will ensure that the safety and performance of your vehicle is maintained for your complete peace of mind.

Please note that fitment of non-genuine parts may invalidate the vehicle warranty if a subsequent fault occurs due to fitting sub-standard replacement parts or accessories.

Jaguar parts distribution service

Jaguar Dealers stock a large number of parts to keep your vehicle maintained and back on the road as quickly as possible. Their service is backed-up by Jaguar's central parts warehouse in Coventry, England, providing next day delivery to most of Europe's Dealers and world-wide within two to three days.

Accessories

A full range of Jaguar Engineering approved accessories including safety, stowage, touring, leisure and lifestyle products are just some of those available from your Jaguar Dealership.

Please ask your Jaguar Dealer for an up-to-date brochure so you can select your requirements from the latest range.

1-2 Owner information

Warnings, Cautions and Notes

Take particular note of WARNINGS, CAUTIONS and Notes given throughout this handbook.



WARNING:

A warning is a procedure which must be followed precisely to help avoid the risk of personal injury.

Caution: A caution is a procedure which must be followed precisely to reduce the possibility of damage to the vehicle and resultant risk of personal injury or inconvenience.

Note: A note is a procedure which will help avoid difficulties in the operation of the vehicle.



Warning symbols on the vehicle

On encountering the warning triangle or open book symbol on the vehicle, it is important that before touching this part of the vehicle or attempting adjustments of any kind you consult the relevant section of this handbook.

Caution: Do not remove any warning labels from the underbonnet area or inside the vehicle.

Vehicle Handbooks

Remember to pass on the Vehicle Handbooks when reselling the vehicle. Handbooks are integral parts of the vehicle.

Health and safety



WARNING:

1. Many liquids and other substances used in vehicles are poisonous and should never be consumed and must be kept away from open wounds. These substances include anti-freeze, brake fluid, fuel, windscreen washer additives, lubricants and various adhesives.
2. The presence of any unusual fumes (for example, petrol or exhaust fumes) in the passenger compartment and/or luggage compartment should be corrected immediately by a Jaguar Dealer. If you must drive under these conditions do so only with all windows fully open.
3. By operating other electronic equipment (for example; a mobile phone without an exterior antenna) electro-magnetic fields can cause malfunctions of the vehicle electronics. Therefore, you should observe the instructions of the equipment manufacturers.
4. Any modifications to the fuel system not specifically designed for this Jaguar are prohibited. Such modifications in some circumstances could result in a fire. All service actions must be entrusted to a Jaguar Dealer.
5. Alterations to the electrical system, including the fitting of accessories not designed for this Jaguar, will cause damage to the electrical circuits and systems. In some circumstances this could result in a malfunction or fire. All accessory work should be entrusted to a Jaguar Dealer.
6. No attempt should be made to repair a fuse that has blown. Always install a new fuse of the correct amperage. Failure to comply with the above may cause a fire hazard or create serious damage elsewhere in the electrical circuit.
7. Avoid contact with battery acid which is poisonous and corrosive. Acid will cause burns to the skin as well as to the eyes. In the event of skin or eye contamination, wash the affected area with water thoroughly. Seek immediate medical attention when eye contact has occurred.
8. Do not disconnect any pipes in the air conditioning refrigeration system. A refrigerant is used which can cause blindness if allowed to contact the eyes. If refrigerant should contact the eyes or skin, wash the eyes or affected area with cold water for several minutes. Do not rub. As soon as possible thereafter, obtain treatment from a doctor or eye specialist.

1-4 Owner information

Regular servicing

Each vehicle is given a full 'Pre-Delivery Inspection' to ensure that all systems function correctly and that the vehicle meets its specification.

Owners are responsible for the regular maintenance and servicing of the vehicle. Jaguar Dealers will be pleased to arrange periodic servicing and can provide you with details of tasks carried out at each service interval.

Failure to implement maintenance at the recommended intervals could result in deterioration of vehicle performance and possible infringement of regulations.

Regular routine maintenance not only helps to prevent unnecessary 'breakdowns' and inconvenience, but enhances the 'trade in' or resale value of the vehicle.

Jaguar diagnostic system

Many of the vehicle systems are controlled by complex electronic devices. Specialist equipment is required to trace and rectify faults in the systems and ensure that only faulty components are repaired or renewed.

Caution: Severe damage to the electrical system and electronic components can occur if any attempt is made to diagnose faults in the electrical system using conventional diagnostic equipment (for example, the use of test lamps or low impedance voltmeters). The fitting of any electrical accessory should only be entrusted to a Jaguar Dealer.

Vehicle identification

Vehicle identification number (VIN)

It is essential that the Vehicle Identification Number (VIN) is quoted in all correspondence and when ordering replacement parts.

The number is visible from outside the vehicle, on a plate in the lower left edge of the windscreen.

Vehicles have the Certification Label adhered to the left-hand front door hinge post. Vehicle weights, paint code manufacture date and the VIN are shown on this plate.

Engine number

Stamped on a raised/machined boss above the oil pan seam directly behind the oil filter adapter plate.

Transmission number

On a metal label or bar code label attached to the transmission casing.

Protect the environment

We must all play our part in protecting the environment. Correct vehicle usage and disposal of waste cleaning and lubrication materials are significant steps towards this aim.

Avoid using high engine speeds. You will then protect your engine, reduce fuel consumption, lower the engine noise level and help towards reducing the environmental burden.

Dispose of batteries, tyres, engine, brake and coolant fluids at your local authorised waste disposal facilities.

Mobile/portable telephones



WARNING:

Using a mobile/portable telephone without an exterior antenna is not recommended when driving as the electro-magnetic fields produced can cause malfunctions with the vehicle electronic systems.

Check the laws and regulations on the use of cellular telephones in the areas where you drive. Always obey them. Also, give full attention to driving.

Use hands-free operation (if fitted) and pull off the road and park before making or answering a call, if driving conditions so require.

Window tinting



WARNING:

Do not have your vehicle windows tinted with a metal oxide tinting (for maximum heat reduction from sun load) if you have a Navigation or Jaguar Telematics system fitted to your vehicle.

Metal oxide tinting prevents the reception of the Global Positioning Satellite (GPS) signals by the antenna causing the navigation system to stop functioning.

This will also prevent the emergency Jaguar Telematics feature from giving the emergency centre your vehicle location.

A non-metal tinting should be used if you require window tinting and if in doubt, contact your Jaguar Dealer for advice.

1-6 Owner information

Touch-screen display

Touch-screen use and care

A touch-control screen is installed in certain vehicles and provides touch-control of vehicle climate, audio, navigation, television and telephone systems, as fitted. A small LCD screen below the touch-control screen provides digital display of the time, ambient temperature and vehicle cabin set temperature.

When the ignition switch is initially turned to position 'I', or 'II', the touch-control screen will display the Jaguar screen saver followed by activation and display of the mode previously used. Display of touch-controls for other systems can be obtained by pressing the appropriate perimeter button and these are described in the appropriate Handbook. Climate control operation is contained in Section 5 of this Handbook. Functions of the 'MENU' button are described on the following pages.



WARNING:

In the interests of road safety, do not attempt to use the touch-screen controls when driving.

Caution: Care must be taken to avoid spilling or splashing drinks onto the screen. In the event of such an occurrence advise your Jaguar Dealer.

Note: When operating touch-screen controls, always extend the tip of one finger, and withhold the thumb and remaining fingers from the screen.

The touch-screen and inner bezel must be kept clean to maintain optimum performance. Finger marks and attracted dust should be regularly removed using a soft cloth and a Jaguar approved cleaning agent.



Touch-control screen



Menu

Pressing the 'MENU' button will show the 'SYSTEM MENU' screen.

'TV' is only available in certain countries. If TV is available, see the accompanying TV Handbook for user instructions.

The screen display can be blanked out at any time when the 'SYSTEM MENU' is in use, by selecting the 'Screen Off' touch-control. Touch the screen to restore the menu.

Alternatively the Jaguar logo can be displayed by selecting 'Screen Saver'.



SYSTEM SETUP

On selection of 'SYSTEM SET-UP', the screen will display the touch-controls which can then be used to set the clock and user settings.

Vehicles which have the Voice Activation system fitted will have an additional touch button on the system setup screen for voice training. This is described in the Voice Activation Handbook.



USER SETTINGS

User settings provides YES/NO control for button and touch-control audible feedback, units of measurement and selection of language.

To select the language, press change and, if the country is not shown on the screen, scroll to the desired country. To select country, press the flag of the country and confirm by pressing **OK**.

Units of measurement provides either imperial or metric units for use with the navigation feature.

'Softkeys' is any switch, slider or button on the touch-screen display.

1-8 Owner information



SET CLOCK

Clock adjustment is made by pressing the hour or minute, up or down button.

12/24 switches the clock between twelve or twenty-four hour display.



VOLUME PRESET

Volume preset provides touch-control adjustment of volume associated with the Navigation, Voice control, Phone, Traffic information and Automatic volume control (AVC) systems. Adjustment of AVC varies the rate at which volume is increased or decreased relative to vehicle speed.

Press and hold the plus or minus symbol to adjust the volume of the selected function.

Note: If any of the volume sliders are adjusted to the fully '-' position then the volume is turned off.



BRIGHTNESS/CONTRAST

Brightness/contrast provides touch-control adjustment of screen display characteristics.

Press and hold the plus or minus symbol to adjust the selected function.

Screen brightness and contrast can also be dimmed for night driving. This is achieved either manually via the 'DAY', 'NIGHT' or 'TWILIGHT' touch-controls, or automatically via selection of the 'AUTO' touch-control and subsequent operation of the vehicle exterior light switch.

SCREEN OFF/SCREEN SAVER

The screen display can be blanked out at any time when the 'SYSTEM MENU' is in use, by selecting the 'SCREEN OFF' touch-control. Touch the screen to restore the menu.

Alternatively, the Jaguar screen saver can be displayed.



Jaguar Telematics

Introduction

Emergency/roadside assistance or access to information is provided by the Jaguar Telematics system. The system uses the vehicle's Jaguar in-car telephone installation to communicate with the Jaguar response centre.

Jaguar Telematics can be used wherever a cellular phone service is available.

Caution: Do not press the SOS button on the overhead console or on the touch screen unless you have an emergency and require the emergency services. If you require information press the 'i' button on the overhead console or on the touch screen.

Before using the system

Registration and acquaintance

The registration procedure will have been completed by your Jaguar Dealer.

Limitations of the system



WARNING:

It is important that the operation of the system is properly understood before attempting to use it. Note the following summary of limitations:

- The system is powered by the vehicle battery and will not operate if the battery is discharged or disconnected.
- The system will only operate in areas with cellular phone coverage and when connection to the network is established. This can be affected by adverse weather conditions, geographical features or tall buildings.
- Loss of contact with the Global Positioning Satellite System (GPS) system could result in an inaccurate vehicle position being sent to the response centre.
- If the vehicle is involved in an accident, components could be damaged rendering the system inoperative.

1-10 Owner information

Emergency assistance (SOS)

The emergency assistance feature allows access to the emergency services (police, fire, or ambulance). Once assistance has been requested, and the vehicle location confirmed, the appropriate services are contacted for assistance to be despatched.

The benefits of the system are:

- ease of activation
- no requirement of knowing who to call
- emergency assistance call sent automatically in the event of airbag deployment
- vehicle location identification based on GPS data sent to the operator.

Emergency assistance can be used in the following situations:

- If you have been involved in an accident.
- Airbag deployment (emergency assistance call sent automatically).
- When urgent medical attention is required.

The GPS is used to identify the position and direction of travel of the vehicle.

Emergency help will be despatched to your location and the operator will, when appropriate, stay in direct contact with you until the emergency help arrives.

Data message

When contact with the response centre is established, an electronic data message is automatically transmitted to the response centre computer. This data message will include:

- Type of alarm (information, emergency or airbag deployed).
- Vehicle identification number (VIN).
- Latitude and longitude coordinates.
- Vehicle position history.
- Time tag identifying when last position was taken.

Information assistance (Info)

Information assistance may be used to request help, breakdown assistance or services from the response centre operator. List of services will depend upon facilities available to the response centre operator, which may include information regarding local hotels, local petrol stations, shops and services and traffic information.

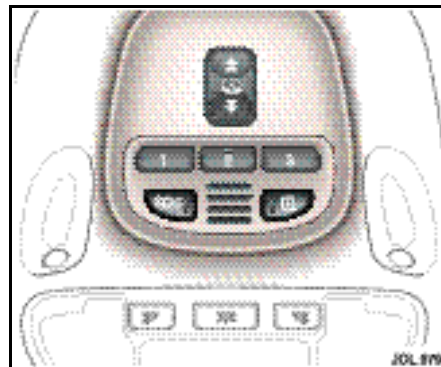

Operation of the system

Note: The ignition must be turned on (position 'I').

The system is operated from the controls on the touch-screen or the overhead console buttons. While in use, the touch-screen or radio displays a sequence of messages and the red lamps in the overhead console buttons will flash to indicate activation.

Note: The phone handset will be switched off during an assistance call.

Call activation and termination

Operation will continue even if the ignition is turned off following an activation.

Note: Once a call has been initiated, do not attempt to crank the engine as this may cancel the activation.

Making an emergency call (SOS)

The procedure for obtaining emergency assistance is as follows.

- Press and hold the SOS button in the overhead console for 2 seconds or
- Touch and hold the SOS button in the touch-screen for 2 seconds.

A call to the response centre is automatically sent using the Jaguar in-car telephone.

Note: If a call is initiated and the operator cannot establish voice communication, police assistance will be despatched to the vehicle, based on the vehicle location when the button was pressed.

The screen or radio shows 'SOS REQUEST' and the red lamp in the SOS button starts to flash.

Operator contact

After the data message transmission has been completed, voice contact with an operator is established. The operator will have available the details of the vehicle, including its last location.

Requesting Information

- Press and hold the 'i' button in the overhead console for 2 seconds or
- Touch and hold the 'Info' button in the touch-screen for 2 seconds.

A call to the response centre is automatically sent using the Jaguar in-car telephone.

The operator verbally obtains details of the information request and the appropriate assistance will be provided.

Terminating assistance calls

When the operator is satisfied that the situation has been dealt with, the call will be terminated and the red lamp in the SOS button will extinguish. Normally, only the response centre can terminate an SOS call.

Terminating an information call

An information call may be terminated via the radio or touch screen or by the response centre.

1-12 Owner information

Further information

On-screen messages

During an assistance call, various status messages are displayed on the radio or navigation screen, which enable the progress of the call to be followed. A list of the messages and their meaning is shown later in this section of the Handbook.

While in contact with the response centre, the vehicle location messages (LATITUDE and LONGITUDE) are displayed in sequence, except when the display of another message is required.

System self-test

The system will perform a self-test each time the ignition is turned on (position '1'). This is indicated by the illumination of a red lamp in the Information and SOS buttons. The lamp will remain illuminated for the duration of the test. If the lamp does not extinguish within 10 seconds, and stays on continuously, contact your Jaguar dealer.

Cellular phone interface

If the phone is in use when the system is activated (for example an airbag deployment) that call will be terminated and a call to the response centre will be made.

When an activation is terminated, your phone is left unlocked if the ignition is still ON. If the ignition is in the OFF position the phone will be switched off after 5 minutes (see the Telephone Handbook).

Battery disconnection

If the battery has been disconnected, the vehicle location will be lost.

On reconnection, it may take up to approximately 15 minutes to re-establish accurate vehicle position.

Message list

During operation, a sequence of messages will appear on the radio or navigation screen. These are described below.

Message	Meaning
EMERGENCY REQUEST	Emergency call initiated (UK only)
SOS REQUEST	Emergency call initiated (Not UK)
INFO REQUEST	Information/Roadside Assistance call initiated
CALL IN PROGRESS	Call is being processed
DIALLING RESPONSE CENTRE	Response centre is being contacted
SENDING LOCATION DATA	Vehicle location data being sent to the response centre
DATA RECEIVED	Vehicle location data received by response centre (US only)
ID XXXXX XXXXX	Vehicle identification number
LATITUDE XXXX XXXX	Vehicle position – latitude
LONGITUDE XXXX XXXX	Vehicle position – longitude
CELLULAR NETWORK BUSY	Trying to connect to response centre
PLEASE WAIT	

1-14 Owner information

Message list (continued)

Message	Meaning
NO CELLUAR SIGNAL	Trying to connect to network
WAITING TO ACQUIRE	
UNABLE TO PLACE CALL	Call failed
SYSTEM FAULT	System failed. See your Jaguar dealer.
REDIAL IN PROGRESS	Redial sequence initiated
NO SIM CARD AVAILABLE	System SIM card missing

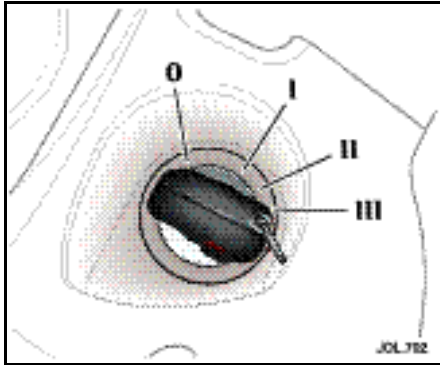

Ignition switch

The ignition switch, on the right-hand side of the steering column, has four key positions:

- 0 __ ignition OFF
- I __ auxiliary
- II __ ignition ON
- III __ engine start

Position '0': is the only position in which the key can be inserted and removed.

Position 'I': allows use of some electrical circuits, for example, radio operation. The airbag system is activated in this position.

Position 'II': all electrical circuits except the starter motor are activated. The key remains in this position when driving.

Position 'III': the starter motor is operated.

To remove the ignition key:

Manual transmission vehicles only:

Apply the handbrake and turn the key to position '0'. The key can then be removed from the switch.

Automatic transmission vehicles only:

Automatic transmission vehicles have a key interlock feature.

Apply the handbrake, place the gear selector in 'P' and turn the key to position '0'.

The automatic transmission gear selector must be placed in Park 'P' before the key can be removed from the ignition switch. When the key is removed, the gear selector will be locked in Park.

Gear-shift interlock

A brake pedal/gear-shift interlock system is incorporated in the automatic transmission gear selector mechanism.

To move the gear selector from Park:

1. Turn the ignition key to position 'II' or start the engine.
2. Press the brake pedal.

Steering column lock

When the ignition key is removed from the ignition switch the steering column lock is engaged. The lock is disengaged when the key is inserted into the ignition switch and turned to position 'I'.

In rare circumstances it may be necessary to gently turn the steering wheel from side to side to release the steering column lock.

2-2 Security and locks

Vehicle security

When leaving the vehicle unoccupied, remember the following:

- Apply the handbrake and with automatic transmission, move the gear selector to Park 'P'.
- Do not leave children or pets in the vehicle unattended.
- Do not leave luggage or valuables on view. Always take your valuables with you or lock them in the luggage compartment.
- Remove the ignition key and spare keys, even when the vehicle is in your garage.
- Close all windows and lock all doors securely.
- Park the vehicle where it can be seen. At night, park in a well-lit area.
- When leaving the vehicle unattended, for maximum security ensure that the doors are double-locked.

Ensure that all keys and key transmitters are removed from the vehicle before locking the doors, and that all doors, the luggage compartment and the bonnet are closed.

It is important to keep your keys in safe places at all times. Leaving them in conspicuous places is an invitation for a thief to steal them and, consequently, your vehicle or belongings. Keep them as secure as you would your wallet or purse, both at home and away.

Immobilisation system security light

This vehicle is equipped with an immobilisation system.

An electronic device is fitted in the head of each key which is programmed to the vehicle electronics. When the key is placed in the ignition switch the vehicle electronics recognise the correct key and allow engine start. The engine cannot be started with a key not programmed to the vehicle electronic systems.

If an ignition key is placed in the ignition switch and turned to position 'II' and the alarm security light on the centre console remains flashing after three seconds, it is possible that the engine will not start. In any event, please contact a Jaguar Dealer to investigate the cause of the light flashing.

Keys

The key, which is integrated with the remote transmitter, operates all the locks on your vehicle.

Vehicles are supplied with two key transmitters.

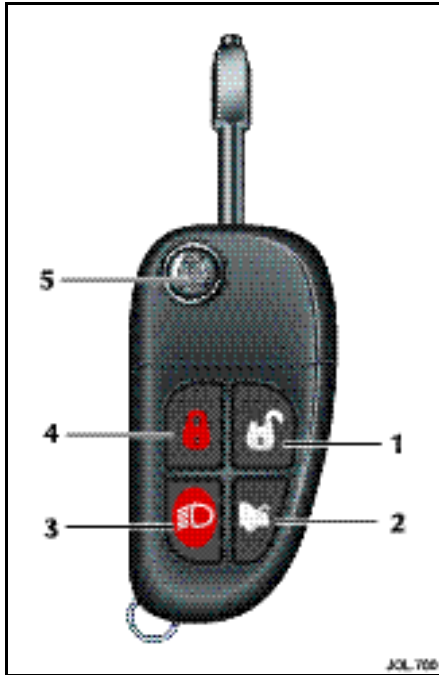

Key transmitter

The security system is controlled remotely by a radio frequency, battery-operated, integrated key transmitter.

The transmitter is activated by pressing one of the operating buttons.

1. Unlocks and disarms the vehicle.
2. Releases luggage compartment lock.
3. Activates the convenience headlamp feature and sounds the panic alarm.
4. Locks/double-locks and arms the vehicle.
5. Lock/unlock the key.

To free the key, press the release button (5). When not required press and hold the button and fold the key into the transmitter housing.

Note: Key transmitters will not operate if a key is in the ignition switch.

Each integrated key will operate the ignition switch and lock the doors.

The key number is recorded on a label which is attached to each key. Detach the label and keep safely, not in the vehicle.

Additional keys and key transmitters can be obtained from your Dealer and can be used provided a Dealer programmes them all to the vehicle.

Caution: Should a key or key transmitter be lost, a new one can be obtained and programmed to the vehicle by a Jaguar Dealer, who will ask for proof of vehicle ownership. It is advisable to notify a Dealer as soon as a key or key transmitter is lost or stolen and have the remaining key(s) or key transmitter(s) reprogrammed. This will then prevent the lost or stolen key/key transmitter from being used to disarm and unlock the vehicle.

Note: Dealers keep a log of all enquiries for replacement keys and notify Jaguar Cars Ltd. of any such requests.

Care of key transmitters

The key transmitters must be treated with care and not exposed to extremes of heat, dust, humidity or be in contact with fluids. Do not leave the transmitter exposed to direct sunlight.

The battery is the only serviceable part.

2-4 Security and locks

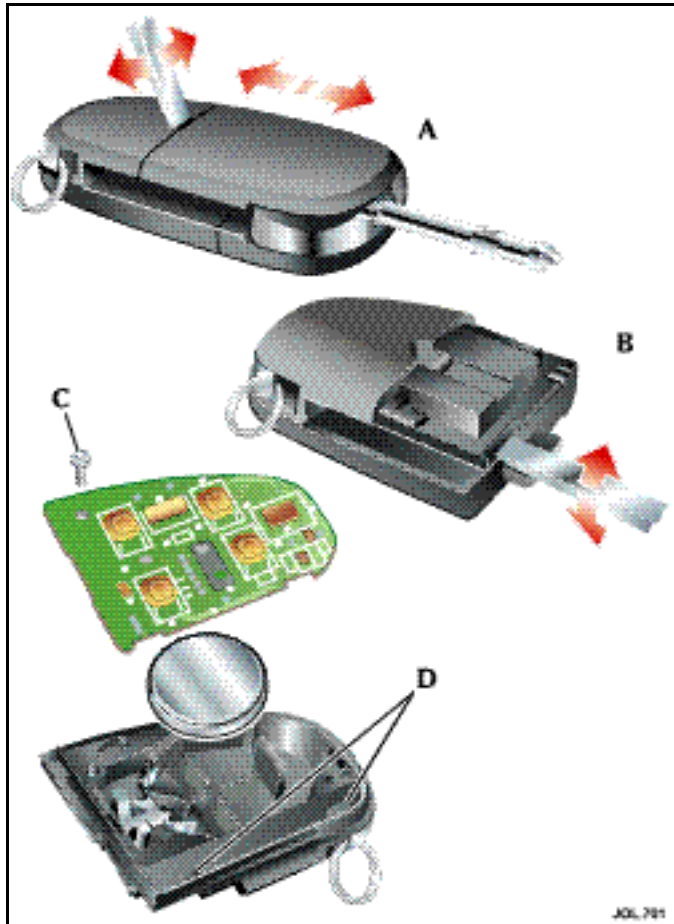

Key transmitter battery renewal

When the battery needs renewal there will be a significant decrease in the effective range of the key transmitter.

To renew the battery, using a small, flat-blade screwdriver, separate and pull the transmitter (A) from the key body. Insert the screwdriver into the groove between the covers (B) and, by twisting the screwdriver, prise the covers apart. Unscrew and remove the small screw (C) and remove the printed circuit board, taking care not to touch the battery terminals. Remove the battery and dispose of it safely. Fit a new cell, type CR2032, available from your Jaguar Dealer, with the side marked with the positive symbol (+) downwards in the battery receptacle. Avoid touching the new battery as moisture/oil from the fingers can reduce the life of the battery and corrode the contacts. Replace the printed circuit board making sure to engage the board under the securing tabs (D), and secure with the screw. Refit the cover and click into place with thumb pressure. Slide the transmitter back onto the key body.

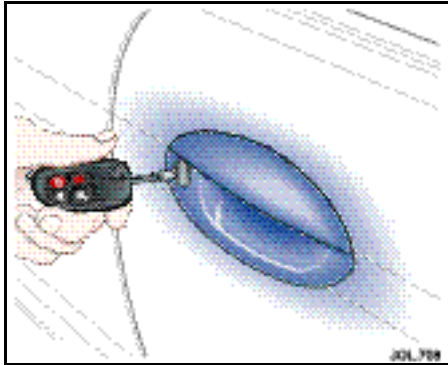

Door locks and handles

All doors can be locked and unlocked using a key transmitter or key.

Smart locking

This feature helps prevent locking the key in the vehicle. If one of the front doors is open and an attempt is made to lock the doors using a door interior locking lever, all doors will become unlocked.

If a door, bonnet or luggage compartment is open the vehicle can only be locked from the outside by using a key in the driver's door lock.

It will not be possible to lock the vehicle with a key transmitter if a door, luggage compartment or bonnet is open.

Vehicle locking and unlocking

To lock the vehicle and set alarm

- Press the lock button on the key transmitter, or
- Put the key in the driver's door lock, turn the key towards the rear of the vehicle and release.

The direction indicators will flash once, the security light on the centre console will start flashing and, after 20 seconds, the alarm will be set.

If a door, the bonnet or the luggage compartment lid are open and an attempt is made to lock the vehicle, the direction indicators will flash five times and the horn will chirp twice as a warning that the vehicle is not secure.

Note:

1. Ensure that the manually operated rear windows are closed.
2. If the vehicle is locked and the transmitter lock button is pressed, the horn will chirp once to confirm the vehicle is secure.

To unlock and disarm the vehicle Using a key transmitter

- Press the unlock button on the key transmitter.

This unlocks all doors and luggage compartment and turns on the interior lights. The direction indicators will flash five times if a fault exists with the intrusion sensing or inclination sensing systems.

Using a key

- Put the key in the driver's door lock, turn the key towards the front of the vehicle and release.

The exterior direction indicators give two flashes as unlocking takes place. Unlocking the vehicle turns on the interior lights.

European countries and United Kingdom only: If the vehicle is unlocked with a key when it is armed, a ticking sound will be heard when the driver's door is opened. This is a warning to indicate that the vehicle alarm will activate after 15 seconds unless the security system is disarmed by either pressing the unlock button on the key transmitter or by placing the key into the ignition switch and turning the key to position 'I'.

2-6 Security and locks

Note:

1. If a passenger door is opened during this period, before the vehicle is disarmed, the alarm will sound.
2. Unlocking with the key does not disarm the security system, this provides extra protection against vehicle theft.

For all other countries: unlocking the vehicle disarms the alarm system.

Global closing



WARNING:
Ensure that all occupants are kept clear of the windows and sunroof aperture.

Using the key in the driver's door, lock the vehicle and hold in this position to close all the electrically operated windows (and sunroof, if fitted).

Using a key transmitter, press and hold the lock button for longer than 1½ seconds to close all the electrically operated windows (and sunroof, if fitted). Pressing the lock button while global closing is taking place will cause all movement to stop.

Note: Manually operated rear windows will not global close. Ensure when locking the vehicle that the rear windows are fully closed.

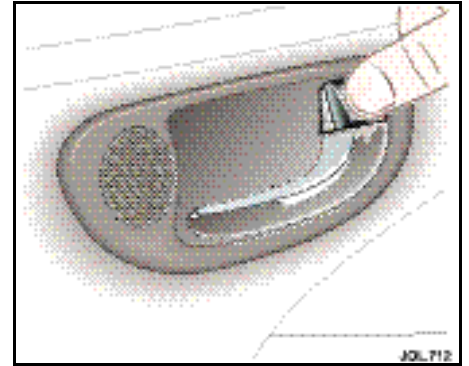

Internal door locking and unlocking

To centrally lock all doors, press the lock lever on the driver's or front passenger's door.

To lock a rear door, press the lock lever.

To unlock a front door, pull the release handle or the lock lever.

To unlock a rear door, pull the lock lever.

The driver's or front passenger's door lock lever will unlock all doors.

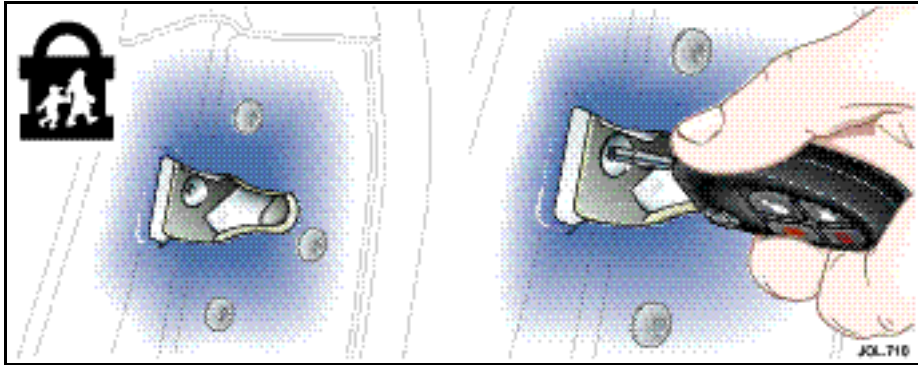

With all doors closed, press the lock button on the key transmitter twice within three seconds to double-lock the vehicle and set the alarm. Alternatively, place the key in the driver's door lock, turn the key towards the front of the vehicle and then towards the rear within three seconds.

The exterior direction indicators will flash, once as locking takes place and a longer, second flash as double-locking takes place.

Drive-away door locking

With the ignition key at position 'II' and all doors closed, all doors will lock when the vehicle is moving above 5 mph (8 km/h). If the vehicle is stopped and a door is opened, provided the engine remains running, the car will relock when the door is closed and the vehicle is moving. If the car is unlocked this feature will only lock the doors again if the ignition is turned off and then back on. All vehicles have the drive-away door locking feature installed during manufacture. This feature can be disabled, or reinstated, by a Jaguar Dealer, if required.

Child safety locks

Child safety locks are fitted to the rear doors.

Open a rear door, insert the ignition key into the lock and turn the key outwards. This immobilises that door interior handle. Repeat this for the opposite rear door.

After setting the child lock the door(s) can only be opened using the exterior door handle.

To remove the child lock feature, open the door and using a key, move the control to its original unlock position.

Double-locking



WARNING:
When the vehicle is double-locked the doors cannot be opened, either from inside or outside the vehicle, except with the correct key or key transmitter. Breaking a window will not allow a thief access by opening a door. Therefore, double-locking should not be used when persons are inside the vehicle as they will not be able to vacate, or be released from the vehicle if an emergency arises.

Note: It will not be possible to double-lock the vehicle if any door is open.

2-8 Security and locks

Auto-relocking

This feature automatically centrally locks and arms the vehicle if the vehicle has been unlocked with the key transmitter:

- and no door has been opened for 45 seconds or
- if the ignition remains off for 45 seconds.

This feature can be disabled, or reinstated, by a Jaguar Dealer, if required.

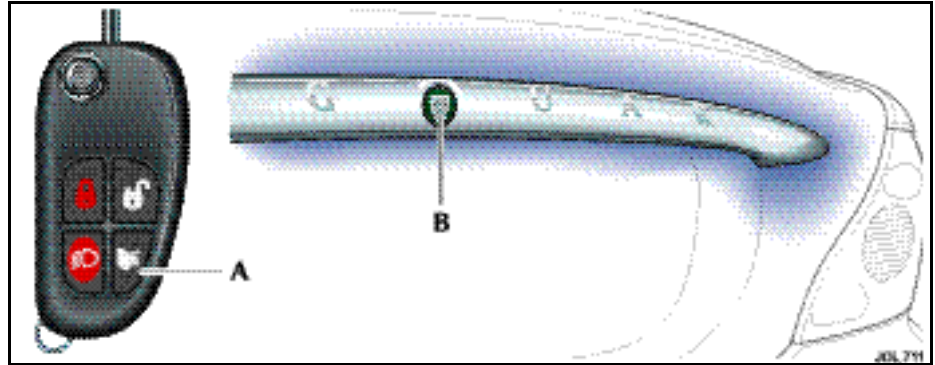

Luggage compartment

To open the luggage compartment:

- press the luggage compartment button (A) on the key transmitter or,
- with the vehicle unlocked, press the release button (B) on the compartment lid.

If the vehicle alarm system is armed and the luggage compartment is opened using the key transmitter the alarm will not sound. The system will be rearmed when the lid is closed, provided the vehicle has not been disarmed.

Alarms and audible signals

Note: In certain markets, legislation prohibits the use of audible confirmation signals. In such cases, the sound source has been removed from the system.

Audible signals

Two horn chirps will sound if an attempt is made to lock the vehicle with the key transmitter if a door, the bonnet or the luggage compartment is not fully closed.

European countries and United Kingdom only:

If the vehicle is unlocked with a key when it is armed, a ticking sound will be heard when the driver's door is opened. This is a warning to indicate that the vehicle alarm will activate after 15 seconds unless the security system is disarmed with either the key transmitter or by turning the ignition key to position '1'.

If the vehicle is unlocked with a key when it is armed and any door other than the driver's door is opened, the alarm will sound immediately.

Error signal

The direction indicators will flash five times whenever one of the following conditions is present:

- If any door is open when an attempt is made to lock the vehicle.
- The luggage compartment or the bonnet is not properly closed when an attempt is made to lock the vehicle.
- If there is an electrical failure within the intrusion sensing or inclination sensing systems and an attempt to 'disarm' the security system is made.

Full alarm

Once armed, any of the following circumstances will create a full alarm state, sound the horns and flash the direction indicators:

- Opening a door, luggage compartment lid (except with transmitter) or bonnet.
- Movement in the passenger area (if intrusion sensors are fitted).
- Using a key in the ignition switch which is not programmed to the vehicle.
- If, after 15 seconds from opening the driver's door with a key (European countries and United Kingdom only), the key is not inserted into the ignition switch.
- If the inclination sensor (if fitted) is activated.
- Any attempt is made to remove the radio.

2-10 Security and locks

Security features

The security system has been designed for:

- Prevention of theft of the vehicle
- Prevention of theft of items from the vehicle
- Personal security

The security system is integrated with the vehicle electronics and engine management systems making it far more difficult for a thief to penetrate and steal the vehicle.

Intrusion sensing

A further enhancement to the security system is the addition of intrusion sensing. When the vehicle is armed and double-locked, movement within the vehicle interior will activate the alarm. The luggage compartment can be unlocked, using the key transmitter button, without sounding the alarm. When the security system is disarmed the intrusion sensors are also disarmed.

Note: Ensure that manually operated rear windows are closed before double-locking the vehicle. This will prevent intrusion sensing falsely sounding the alarm.

Inclination (tilt) sensing protection

This feature protects against unauthorised towing away or jacking up. When the vehicle is double-locked and armed, any tilting of the vehicle, such as jacking or lifting, will activate the alarm.

Note: If the vehicle is being transported by road, rail or sea, the vehicle should not be double-locked. This prevents the inclination system from being armed and sounding the alarm as the vehicle pitches and rolls.

When the security system is disarmed the inclination sensor is also disarmed.

Battery reconnection

If the battery has been disconnected and is subsequently reconnected, the alarm system will resume the same state as before the battery was disconnected.

If the alarm was sounding when the battery was disconnected it will sound again when the battery is reconnected and will need the transmitter unlock button to be pressed or key placed in the ignition switch and turned to position 'I' to disarm it.

Panic alarm

When in or near the vehicle, the alarm can be set off to deter a possible offender. For this feature to operate, the key must not be in the ignition switch.

Pressing the headlamp convenience/panic button on the key transmitter three times within three seconds will activate the 'Panic Alarm'.

The alarm is stopped by:

- putting the key into the ignition switch and turning to position 'II' or
- pressing either the transmitter panic button three times or one press of the unlock button.

Battery back-up sounder

In certain markets a separate, self-contained, battery back-up sounder is fitted. This device will sound the full alarm if the vehicle alarm is activated or if the vehicle battery or the sounder is disconnected when the security system is armed.

Radio frequency approval

If the type approval of your key transmitter requires inspection, refer to the table below.

Type Exam. Certificate Number: CERT 980154-01

Country	Approval No.
Australia	
Austria	
Belgium	
Brazil	
Chile	
Czech Republic	
Finland	
France	
Germany	
Israel	
Italy	

Country	Approval No.
Korea	
Luxembourg	
Netherlands	
Norway	
Portugal	
South Africa	
Spain	
Sweden	
Switzerland	
Taiwan	
United Kingdom	



HomeLink® Universal Transceiver

The HomeLink Universal Transceiver is fitted in the roof console. HomeLink can be programmed to transmit the radio frequencies of up to three different transmitters used to activate garage doors, gates, home lighting, security systems, or other radio frequency operated devices.

If you would like additional information on the HomeLink Universal Transceiver, compatible products or to purchase other accessories such as the HomeLink lighting package, contact your Jaguar Dealer or Homelink on the internet at www.homelink.jci.com.



WARNING:

- 1. Do not use the HomeLink Universal Transceiver with any garage door opener that lacks the safety stop and reverse feature as required by safety standards. A garage door opener which cannot detect an object, signalling the door to stop and reverse, does not meet current federal safety standards. Using a garage door opener without these features increases risk of serious injury or death.**
- 2. When programming the HomeLink Universal Transceiver to a garage door opener or entry gate, make sure that people, the vehicle and objects are out of the way to prevent potential harm or damage as the gate or garage door will activate during the programme.**

Programming

Note: For best results, fit a new battery to the hand-held transmitter before programming. If your garage door opener receiver (located in the garage) is equipped with an antenna, ensure that the antenna is hanging straight down.

1. Switch off the engine.
2. Press and hold the two outermost buttons (1 and 3), releasing only when the indicator light begins to flash after 20 seconds.
Do not repeat this step when programming the additional buttons.
3. Hold the end of the hand-held transmitter of the device you wish to train approximately 1 to 3 inches (25 to 75 mm) away from the HomeLink surface, keeping the indicator light in view.
4. Using both hands, simultaneously push the hand-held transmitter button and the chosen HomeLink button (1, 2 or 3). The HomeLink indicator light will flash, first slowly and then rapidly. When the indicator light flashes rapidly, release both buttons. The rapid flashing light indicates successful programming of the frequency signal.

To programme the remaining buttons, follow steps 3 and 4.

Press and hold the programmed HomeLink button to activate the programmed device and release when the device begins to activate.

If, after 90 seconds, the indicator light does not flash rapidly, release both the Homelink and the hand-held transmitter buttons and repeat the procedure starting with Step 2. However, position the hand-held transmitter at a different angle and/or distance.

If the device does not operate you may need to complete the steps outlined in “Rolling code programming”.

Some entry gates and garage door openers may require you to replace Step 4 with the procedures in the section “Canadian Programming”.

If you are programming a rolling code equipped device, continue with the procedures outlined in “Rolling code programming”.

Note: Keep the original transmitter for future use or programming procedures if, for example, you purchase a new vehicle.

Caution: It is recommended that when you sell or dispose of the vehicle, the programmed Homelink buttons be erased for security purposes.

Canadian programming/Gate programming.

Canadian frequency laws, and the technology of some entry gates, require you to press and re-press (cycle) the hand-held transmitter button every two seconds during programming.

Continue to press and hold the desired Homelink button while you cycle your hand-held transmitter until the indicator light flashes rapidly.

Note: When programming a garage door opener or entry gate, unplug the device during the “cycling” process to prevent possible motor failure.

Rolling code programming.

Rolling code garage door openers (or other rolling code devices) which are “code protected” may be determined by the following:

- reference the device owner’s instruction manual for verification.
- the hand-held transmitter appears to programme the HomeLink Universal Transceiver but does not activate the garage door.
- press and hold the trained HomeLink button. The device has the rolling code feature if the HomeLink indicator light flashes rapidly and then turns solid after two seconds.

To train a garage door opener or other device with the rolling code feature, follow these steps after completing the Programming section instructions.

2-14 Security and locks

Note: The aid of a second person may make the following training procedures quicker and easier.

1. Locate the training button on the garage door opener receiver in the garage. Exact location and colour of the button may vary by garage door opener brand. If there is difficulty locating this button, reference the garage door opener instruction manual or contact HomeLink.

Note: Following step 2 there are 30 seconds in which to initiate step 3.

2. Firmly press and release the training button on the garage door opener receiver which will activate the training light.
3. Firmly press and release the HomeLink button. Press and release the HomeLink button a second time to complete the training process. Some garage door openers may require you to do this step a third time to complete the training.

The device should now recognise the HomeLink signal and activate when the HomeLink button is pressed.

The remaining buttons may now be programmed if this has not been previously done.

Reprogramming a HomeLink button

To programme a device to HomeLink using a button previously trained, follow these steps;

1. Press and hold the desired HomeLink button. Do not release until step 4 has been completed.
2. When the indicator light begins to flash slowly (after 20 seconds), position the hand-held transmitter 1 to 3 inches (25 to 75 mm) away from the HomeLink surface.
3. Press and hold the hand-held transmitter button.
4. The HomeLink indicator light will flash, first slowly and then rapidly. When the indicator light begins to flash rapidly, release both buttons.

The previous device has now been erased and the new device can be activated by pushing the HomeLink button that has just been programmed. This procedure will not affect any other programmed HomeLink buttons.

Erasing programmed HomeLink buttons.

Individual buttons cannot be erased, however, to erase all three programmed buttons:

1. Press and hold the two outermost buttons until the indicator light begins to flash after 20 seconds.
2. Release both buttons.

The HomeLink Universal Transceiver is now in the train, or learning, mode and can be programmed at any time following steps 3 and 4 in the “Programming” section.



WARNING:
The manufacturer is not responsible for any radio or TV interference caused by unauthorised modifications to this equipment. Such modifications could void the user's authority to operate the equipment.

Occupant protection

Seat belts

The use of front and rear seat belts is mandatory in most countries. Using seat belts saves lives. They should be worn by all occupants whenever the vehicle is in use, for maximum protection.

This vehicle has an individual lap/shoulder inertia reel seat belt for each occupant.

The inertia operating mechanism of the seat belts allows the wearers to move their upper bodies to reach various controls. The seat belts will lock automatically with accelerated body movement or in the event of emergency braking. Both front seat belts are equipped with pretensioners to assist restraint and safety belt force limiters to help minimise the risk of upper body injuries.

Seat belt height adjustment is provided for driver and front seat passenger to ensure that the seat belt webbing can be positioned to pass over the shoulder without pulling against the neck. It can be locked in any of five positions.

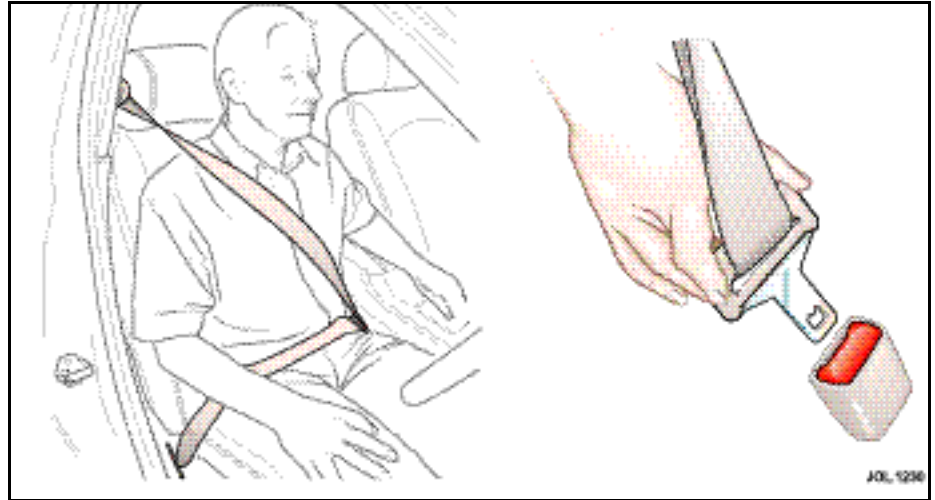

Seat belt fitting



WARNING:
Do not adjust the seat belt while driving.

Draw the tongue of the seat belt over the shoulder, across the chest and push it into the buckle unit slot. A positive 'click' indicates that it is safely locked.

The use of comfort clips or devices that would create slackness in the seat belt system are not recommended.

Always ensure that the webbing is midway between the neck and the edge of the shoulder. Correct tension is controlled by automatic retraction of the reel.

A warning light on the instrument panel comes on for 60 seconds when the driver's seat belt is not fastened. (In some countries, a warning signal sounds for six seconds).

Note: If the vehicle is parked on unlevel ground, the seat belt mechanism may lock. This is not a fault, gently ease the belt from its attachment to unlock it.

3-2 Before driving

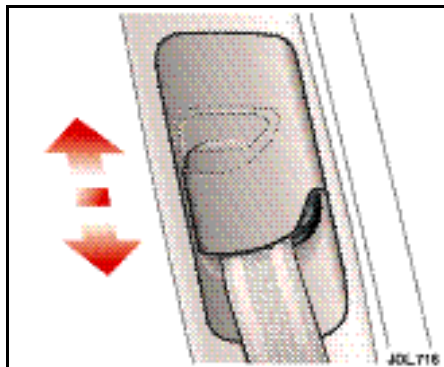

Front belt height adjustment

To operate: Press the locking button and slide the anchorage point to the required position to ensure comfort and safety. Release the button and check that the anchorage point is locked.

Always check the anchorage point after the seat has been adjusted to ensure that the belt is correctly positioned.

Inertia reel mechanism check

Static test: Whilst seated, fasten the seat belt and grip the shoulder belt at approximately shoulder level with the opposite hand. Pull the belt sharply downwards, the belt should lock.

Road test: The following road test must be carried out only under maximum safe road conditions.

With the seat belt correctly fitted to the driver and passenger(s), drive the vehicle at 5 mph (8 km/h) and, ensuring that it is safe to do so, brake sharply.

The seat belt(s) should lock automatically, holding both driver and passenger(s) securely in position.

It is important when braking that the reactions of both driver and passenger(s) are normal, that is, the body must not be thrown forward in anticipation, thus causing a snatching action of the belt which would operate the locking mechanism.

If the belt fails to lock on either test, consult a Jaguar Dealer.



WARNING:

1. **Seat belts are designed to bear upon the bony structure of the body, and must be worn low across the front of the pelvis, or the pelvis, chest and shoulder, as applicable. Wearing the lap section of the belt across the abdominal area must be avoided. Always ensure that the webbing is midway between the neck and the edge of the shoulder.**
2. **Seat belts should be adjusted as firmly as possible, consistent with comfort, to provide the protection for which they have been designed. A slack belt will greatly reduce the protection afforded to the wearer.**

3. Care should be taken to avoid contamination of the webbing with polishes, oils and chemicals, and particularly battery acid. Cleaning may safely be carried out using mild soap and water. If webbing becomes frayed, contaminated or damaged, discard it and fit a new seat belt.
4. It is essential to renew the entire seat belt assembly and the buckle assembly after it has been worn in a severe impact, even if damage to the assembly is not obvious.
5. Belts should not be worn with the webbing twisted.
6. Each seat belt assembly must only be used by one occupant; it is dangerous to put a seat belt around a child being carried on the occupant's lap.
7. No modifications or additions should be made by the user which will either prevent the seat belt adjusting devices from operating, or prevent the seat belt assembly from being adjusted to remove slack.
8. Should the seat belt not retract and remain at its static length, consult your nearest Jaguar Dealer immediately.

3-4 Before driving



Advanced occupant restraint system

In order to provide optimum protection this vehicle is equipped with front and side airbags for driver and front seat passenger. These are supplemental restraint systems which are used in conjunction with the seat belts to help protect the driver and front seat passenger from upper body and head injuries.

Curtain airbags are fitted to the sides of the vehicle for front and rear occupants head protection in the event of a side impact.

To do their life-saving job, airbags open with a great deal of force and this force can pose a potentially dangerous risk in some situations, particularly when a front seat occupant is not properly restrained with the seat belt.

Because airbags must inflate rapidly and with considerable force, there is the risk of death or serious injuries such as fractures, facial and eye injuries or internal injuries, particularly to occupants who are not properly restrained or are otherwise out of position at the time of the airbag deployment.

Airbags do not inflate slowly or gently and the risk of injury from a deploying airbag is greatest close to the trim covering the airbag.

The whole sequence of events from sensing the impact to full inflation of the bag takes place in a fraction of a second.

The driver airbag is located in the centre of the steering wheel and the front seat passenger airbag is located in the fascia panel immediately in front of the passenger seat.

The side airbags are fitted within the driver and front passenger seat outboard seat bolsters, and are identified by a label on the seat.

Curtain airbags are fitted above the doors, under the headlining. These deploy downwards to give protection to the heads of driver, front seat passenger and the outer rear seat occupants.

The airbag warning light in the instrument cluster will be lit for approximately six seconds when the ignition is turned on. If the light remains on or flashes it indicates a fault within the airbag electrical circuits. Report the fault to a Jaguar Dealer immediately.

It is safe to drive the vehicle; however, in an accident the airbags may not operate.



WARNING:

1. No objects whatsoever should be attached to the centre cover of the steering wheel, the passenger fascia panel or the sides of the driver and front passenger seats. Do not put anything on or over the airbag inflation area. Placing objects on or over the airbag inflation area may cause those objects to be propelled by the airbag into your face and torso causing serious injury.
2. Safety experts recommend a minimum distance of at least 10 inches (254mm) between an occupant's chest and a front airbag.
3. Children 12 years old and younger can be killed or seriously injured by the airbag. The rear seat is the safest place for children.
4. Do not try to put an adult seat belt around two children.
5. Several airbag system components get hot after inflation. Do not touch them after they have deployed.
6. Child restraint anchorages are designed to withstand only those loads imposed by correctly fitted child restraints. Under no circumstances are they to be used for adult seat belts or for attaching other items or equipment to the vehicle.
7. DO NOT install a rearward-facing child seat in the front passenger seat position. This is emphasised by the label displayed on the end of the fascia on the front passenger side, as shown on the illustration. If however, you must sit a child in the front passenger seat use only a forward-facing child seat with the passenger seat set fully rearward. Always follow the fitting instructions supplied with the appropriate child restraint system.
8. To ensure that the side airbags are fully effective: DO NOT sit too close to, or lean against, the door trim. The side airbag could injure you as it deploys from the side of the seat. DO NOT lean out of the window aperture. Only use JAGUAR APPROVED accessories (e.g. seat covers). Due to the function of the CURTAIN AIRBAG deployment, CONSULT your Jaguar Dealer prior to installing any ACCESSORIES in the upper environment/pillar trim area (e.g. HANDS-FREE TELEPHONE KITS).
9. If an airbag is inflated, the airbag will not function again and must be renewed immediately. If a new airbag is not fitted, the unrepaired area will increase the risk of injury in a collision.

Airbag warning information is printed on the driver's and passenger's sunvisor. Airbag warning light information is shown on page 4-6.

3-6 Before driving

Wrong
Unbelted and too close

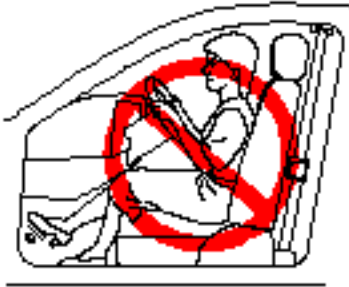

Use Seat Belts

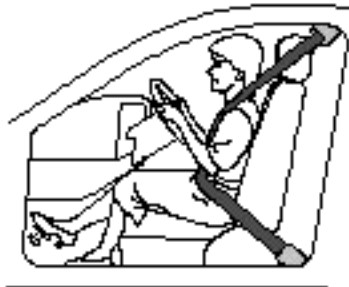

Move Seat Rearwards

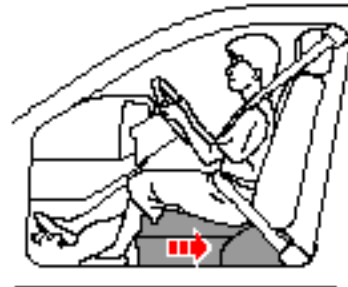

Recline Back of Seat

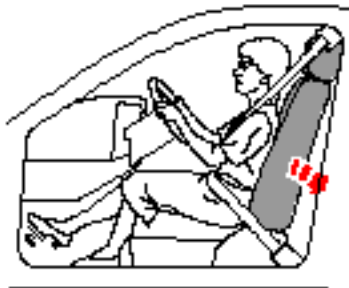

Tilt Wheel Down/Forwards

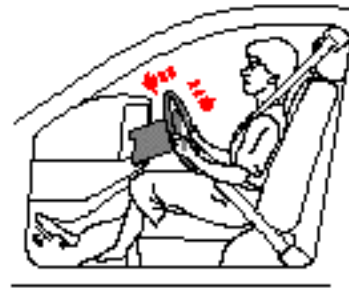

Correct
*Belted and 10inches (254mm)

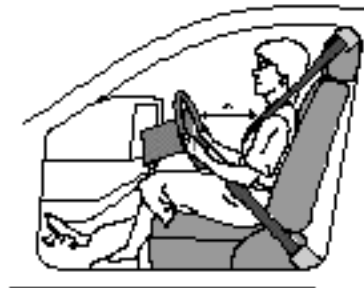



WARNING:

Driver and front seat passenger should always move their seats as far rearwards as is practical.

Ideally, drivers should sit with at least 10 inches (254 mm) between the centre of their breastbone and the cover of the steering wheel airbag.

Since the risk zone at the time of deployment is the first 2 to 3 inches (54 mm–75 mm) from the airbag cover, sitting back 10 inches (254 mm) provides a clear margin of safety. Very few drivers are unable to achieve and maintain that safety gap.

The vast majority of drivers who do not now sit that far back can change their position and achieve that distance.

- Move your seat back as far as you can while still comfortably reaching the pedals.
- Recline the back of your seat one or two notches from the upright position. If reclining the back of your seat makes it hard to see the road, raise yourself by using a firm, non-slippery cushion, or raise your seat, if your seat has that feature.

- Tilt the steering wheel/column downwards so as to point the airbag at your chest instead of your head and neck. Adjust the steering wheel/column fore/aft so that it extends towards the driver as little as possible, ensuring that the airbag has plenty of room to deploy.



WARNING:

Do not attempt to service, repair or modify the airbag system or its fuses. All work on the airbag system, including renewal after deployment and renewal at the end of its service life, must be carried out by an authorised Jaguar Dealer.

In the event of the vehicle being dismantled, airbag module removal and disposal **MUST** be made by a qualified person. Instructions can be obtained from an authorised Jaguar Dealer.

The noise and gas associated with the deployment of the airbags is not injurious to health.

After airbag deployment, it is normal to notice a smoke-like, powdery residue or smell the burnt propellant. This may consist of cornstarch, talcum powder or sodium compounds that result from the combustion process that inflates the airbag.

Small amounts of sodium hydroxide may be present which may irritate the skin and eyes, but none of the residue is toxic.

While the system is designed to help reduce serious injuries, it may also cause minor burns, abrasions, swelling or temporary hearing loss.

3-8 Before driving

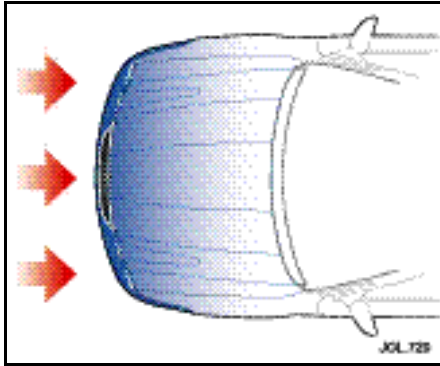

Front airbags

The front airbags use a dual inflation technology and are designed to activate when the vehicle suffers a frontal impact of sufficient force to cause the sensors to close an electrical circuit that initiates airbag inflation. Front airbags use a dual inflation technology which means that, if activated, the bag(s) will deploy at one of two levels of inflation.

Sensors monitor the weight on the front passenger seat. The proximity of the driver to the steering wheel is also sensed. In the event of a collision, the advanced restraint system makes the decision to activate the appropriate airbags, the required inflation level and trigger the seat belt pre-tensioners.

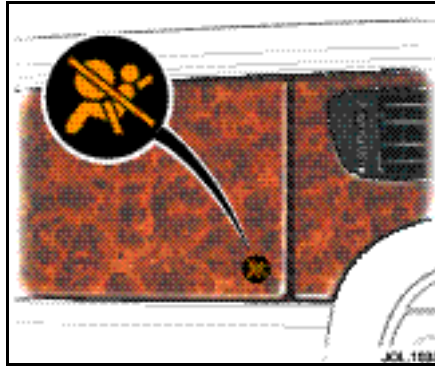

Airbag warning light

The AIRBAG warning light on the passenger fascia is associated with the deployment conditions for front passenger airbags only:

- If the seat is empty, the front and seat mounted side airbags will not be activated and the light will not be lit.
- If the seat is occupied by, for example, a small child, the front and seat mounted airbags will not be activated and the AIRBAG warning light will be illuminated.
- If the seat is occupied by a larger child or adult, the front and seat mounted side airbags will be activated and the warning light will not be illuminated.

With the driver's and front passenger's airbag, the occupant, restrained by the seat belt, moves forward, the head and chest come into contact with the inflated bag. The airbags which then deflate rapidly, in a controlled manner, via vent holes, absorb the remaining energy of the impact.

If the airbags do not inflate in a collision it does not mean that something is wrong with the system.

Rather, it means the forces of the impact were not of the type sufficient to cause activation. Front airbags are designed to inflate in frontal and near frontal collisions, not roll-over, side-impact or rear-impact.

In circumstances where the airbags are not deployed, protection is provided by the seat belts. The severity of the collision is a function of the relative speed and weight of the vehicles or objects colliding. Thus, it is extremely important that occupants be properly restrained as far away from the airbag as possible while maintaining vehicle control.

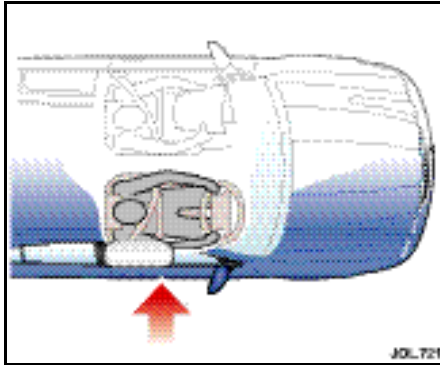

Side protection

The side protection system utilizes four airbags: two seat mounted in the front seats, and two curtain airbags located in the upper environment just above the door openings.

When the seat mounted side airbag inflates upon a vehicle side impact, it breaks through the seat bolster stitching, protecting the side of the rib cage of the driver or front seat passenger.

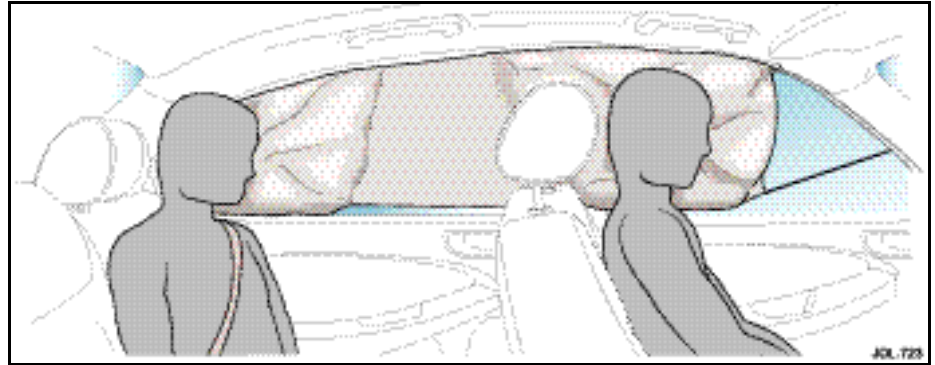

When the curtain airbag inflates upon a vehicle side impact, it breaks through the headlining and deploys downwards, giving head protection to front and rear seat occupants.

The airbags, in combination with the seat belts, can help reduce the risk of severe injuries in the event of a significant side impact collision.

In certain lateral collisions, the airbags on the side affected by the collision will be inflated even if the respective seat is not occupied.

Side and curtain airbags are designed to inflate in a side impact collision, not rollover, rear-impact, frontal or near-frontal collisions, unless the collision causes sufficient lateral deceleration.

3-10 Before driving



Child safety

JAGUAR CARS LTD. STRONGLY RECOMMEND THAT AT ALL TIMES CHILDREN SHOULD BE CARRIED IN THE REAR SEATS.

In many countries legislation governs how and where children should be carried when travelling in a vehicle. It is the responsibility of the driver to comply with all regulations in force in the country where the vehicle is being used.

Holding a baby or child in a person's arms is **not** a substitute for a child restraint system.

In an accident, a baby or child held in a person's arms can be crushed between the vehicle's interior and a restrained person.

The child can also be injured by hitting the interior or by being thrown from the vehicle during a sudden manoeuvre or impact.

Injury can also be caused if the baby or child is allowed to ride on the seat unrestrained. Other occupants should also be properly restrained to help reduce the chance of injuring the child.

Do not allow children to stand in the space between the front seats, or on the rear seats. Children must be restrained by the use of a child safety restraint applicable to their weight and size. The seat must be secured using one of the rear outboard inertia reel seat belts.

Note: A range of safety restraints are available as Jaguar Accessories; consult your Jaguar Dealer for details.

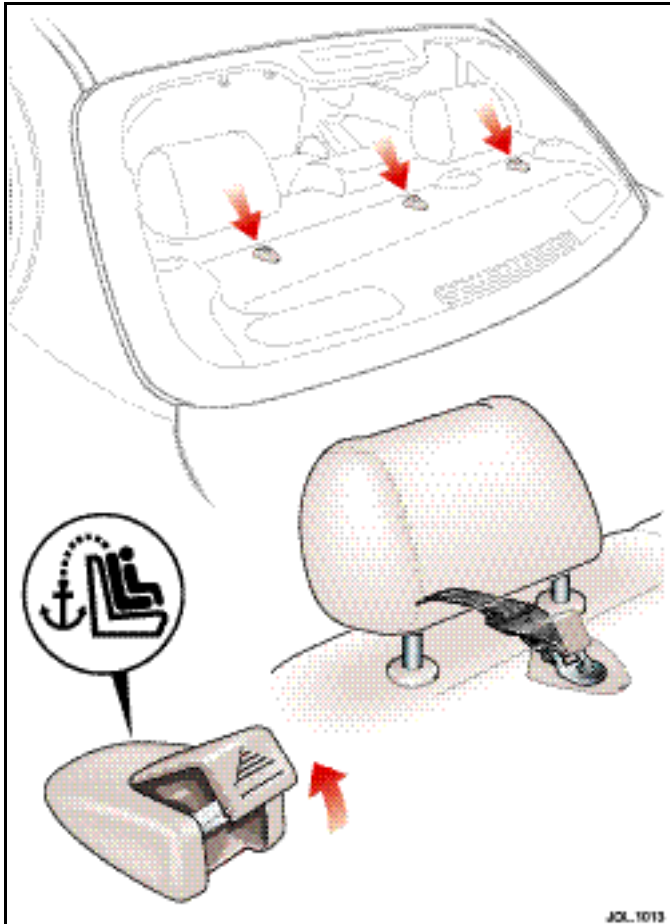

Child restraint tether anchorages and brackets

The tether brackets are positioned on the rear parcel shelf at the centre-line of each rear seating position. The child restraint can be fitted directly to the brackets.

Note: Always ensure that child restraint assemblies are fitted in strict accordance with the child restraint manufacturer's instructions.

Look for the following when selecting a child restraint system:

- It should have a label certifying that it meets the applicable Regulations.
- Carefully read the instructions supplied with the restraint. Be sure you understand them and can install and use the device properly and safely in the vehicle.
- Ensure that the child restraint system is appropriate for the child's weight and development. The label required by the standard or regulations, or instructions for infant restraints, usually provide this information.

Wearing of child restraints

Ensure that there is no slack in the webbing and that the restraint fits the child snugly across the rib cage and hips. These are the parts of the body most able to take the force of impact.

The lap strap should pass across the top of the child's thighs, bearing on the pelvis, not the abdominal area.

Infant safety

Babies and small children who cannot sit up by themselves should be carried in an approved Jaguar baby seat.

3-12 Before driving

Seat adjustment



WARNING:

1. Do not make adjustments when the vehicle is moving.
2. Front passengers must not ride with the seat fully reclined.

Depending upon the vehicle specification, seats have manual and/or electrical adjustment.

Front seat - electrical adjustment

A key does not have to be in the ignition switch for seat adjustment.

The front seats can be adjusted electrically by two switches on the side of the seat cushion.

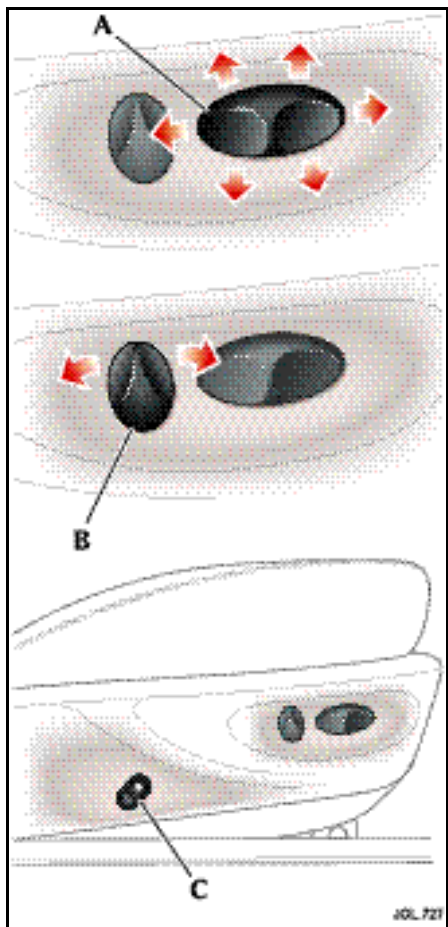

- A.** controls the seat position.
To move the seat forward or rearward – move the switch forwards or rearwards.
Front/rear of cushion raise/lower – move the front or rear of the switch up or down. If both front and rear raise are pulled upwards together the whole seat cushion will rise. If both front and rear lower are pressed down together the whole seat cushion will lower.
- B.** controls the seat back angle.
Move the switch rearwards to recline or forwards to raise the seat back angle.

To adjust the lumbar support, press the switch (C) on the seat. Pressing the top of the switch increases lumbar support, pressing the bottom of the switch decreases lumbar support.

Front seat - manual adjustment

Forward and rearward:

Each front seat can be adjusted forward and rearward by lifting the locking bar(A), situated below the front of the seat cushion and sliding the seat to the required position. After releasing the locking bar, slight additional seat movement may be necessary to engage the locking mechanism.

Height adjustment:

The driver's seat has a switch to adjust the seat for height. The whole seat cushion will raise or lower by moving the switch(B) up or down.

Back adjustment:

To alter the angle of the front seat back, lean forward slightly to relieve body pressure from the seat back and rotate the handwheel (C) in the required direction.

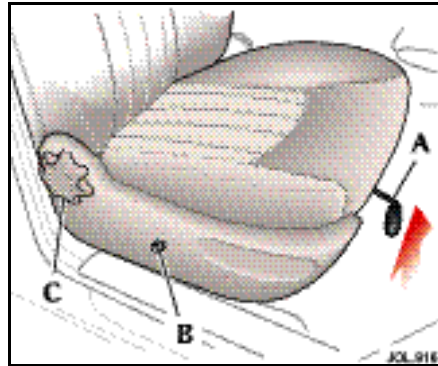

3-14 Before driving

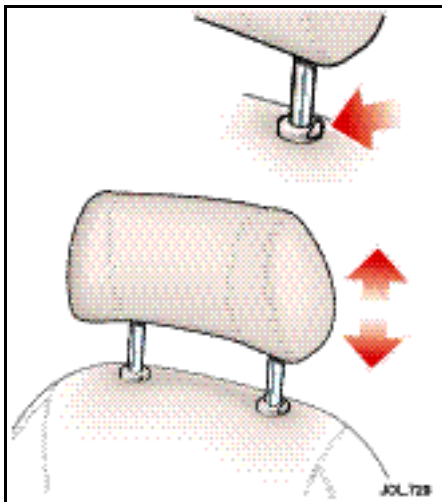

Head restraint adjustment



WARNING:

Adjust the head restraint so that it is just behind your head and never behind your neck.

Each front head restraint can be adjusted to give the correct height for the seat occupant. The head restraints have height and swivel adjustment.

To lower: press the lever in the escutcheon and push the headrest down to the required height.

To raise: pull the headrest upwards.

Rear centre head restraint

The rear centre head restraint has two height positions only. It can be stowed within the seat back when not in use and should be extended when an occupant is in the centre seat.

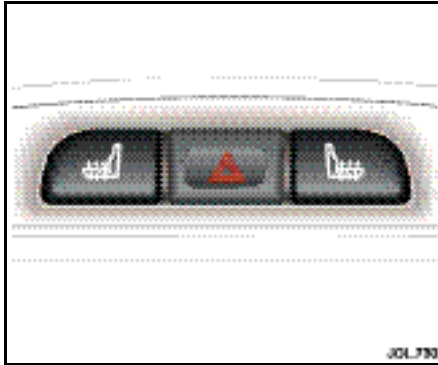

Front seat heaters

Each front seat back and cushion has a heater controlled by a switch on the centre console.

With the ignition switch in position 'II', press the switch to turn the heaters on.

The first press will heat the seat to a high temperature setting, a second press will heat the seat to a lower setting.

A third press will turn the seat heater off.

A light within the switch will show when the heater is ON, red for the high heat setting and yellow for the lower setting.

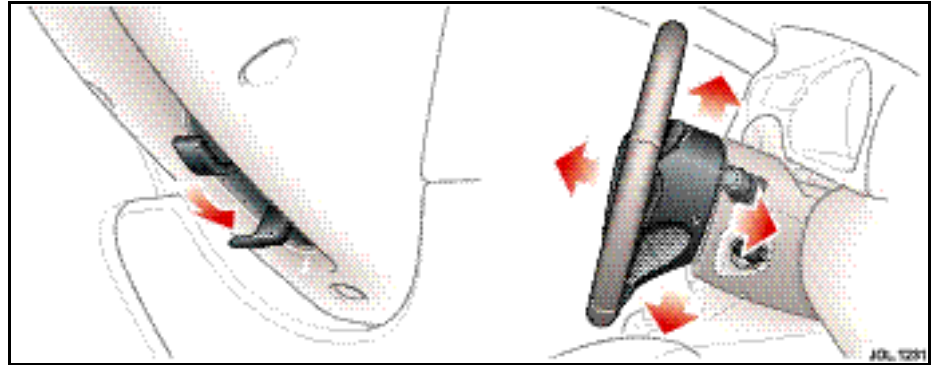

Steering column adjustment



WARNING:

Do not adjust the steering column whilst driving.

The steering column can be adjusted for reach and height.

Holding the steering wheel, push the release lever fully downwards.

Move the steering wheel up or down and in or out as required, for a comfortable, safe driving position.

After adjustment, fully raise the lever to lock the steering wheel in position.

The heater will automatically switch OFF

- after it has been on for 10 minutes
- if the ignition is turned OFF
- if a fault is detected.

The heater will maintain a pre-set temperature while it is switched on. Storage of the vehicle in a heated garage, body heat or warm ambient temperatures may prevent operation of the seat heater.

3-16 Before driving

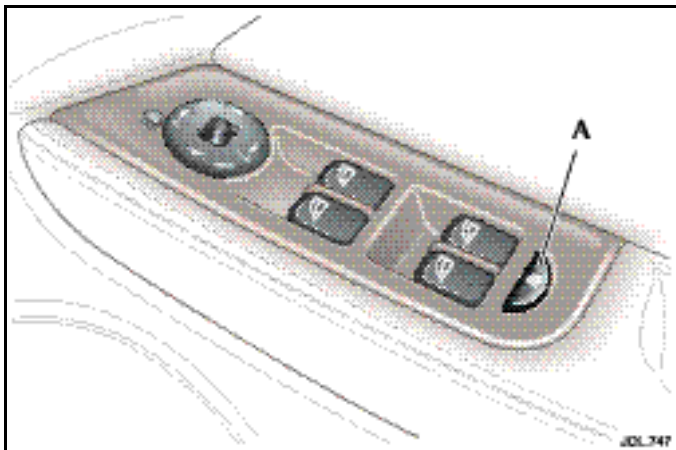

Door window operation

Front windows on all models are electrically operated. Depending on the model, rear windows can be either manually or electrically operated.

Electric window operation

Switches on the driver's door switch pack control the driver and passenger door windows.

The passengers are provided with a switch to control their door window only.

These switches will only operate the window when the ignition switch is in position 'II'.

If electrically operated rear windows are fitted, button (A) immobilises the rear window switches preventing passengers from operating their windows. The button integral red light will be lit when the rear windows cannot be operated by the rear seat passengers.



WARNING:

- 1. When raising windows ensure all occupants are clear.**
- 2. When leaving the vehicle take the ignition keys to prevent misuse of the window switches by remaining occupants, especially children.**

Operation

To lower a window, press down the switch to its first position and hold until the desired position is reached, then release.

To close a window, pull the switch upwards to its first position and hold until the desired position is reached, then release.

If the switches are held for longer than 6 seconds, for example, when attempting to overcome frozen or jammed windows, the window drive will be switched off for a few seconds to protect the window drive motors.

One-touch operation

Each window has a 'one-touch' facility enabling the occupant to fully open or close the window in one quick movement. Pulling, or pressing, the switch to its second position and quickly releasing will close or open the window in one movement. Window travel can be stopped at any time by pressing the switch again.

Window anti-trap feature

Each electrically operated window has an anti-trap feature. If the upward movement of the window detects an obstacle the anti-trap feature will immediately stop the window closing, then move it downwards for a short distance.



WARNING:

If the battery is disconnected or discharged the window anti-trap feature is lost. When the battery is reconnected or recharged the window anti-trap feature must be reset.

To reset the electrically operated windows anti-trap feature:

- Fully close the window, hold the switch in the close position for two seconds and then release the switch. Wait for two seconds, do not open the window.
- Again, select the same window to close, holding the switch for a further two seconds.
- Check to confirm the operation by opening the window and then use one touch operation to close the window.
- Repeat for the remaining electrically operated windows.

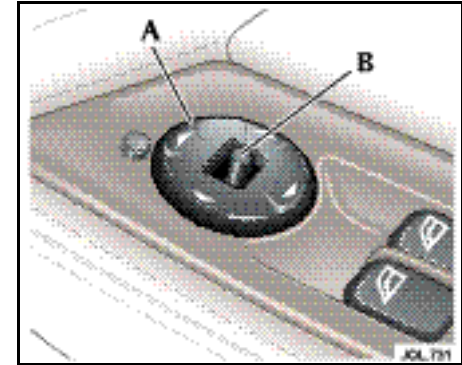

Mirrors

Door rear view mirrors

Both door mirrors are adjusted from the driver's door switchpack. The four-way adjustment button (A) moves the mirrors to the required position. The selector switch (B) selects the mirror to be moved, left for the left-hand side mirror and right for the right-hand side mirror. When the selector switch is in the centre position, adjustment to either mirror is inhibited.

3-18 Before driving

Each mirror housing, except the power fold back door mirror, is designed to pivot against the vehicle upon impact. To return the mirror to its normal position, reposition the housing until it locks into place.

Mirror heating

The door mirrors have heating elements which work when the rear screen heater is switched ON. The mirror heater will clear all ice from the mirror surface.

Caution: Do not use a scraper to remove ice from the mirrors as this will damage the surface.

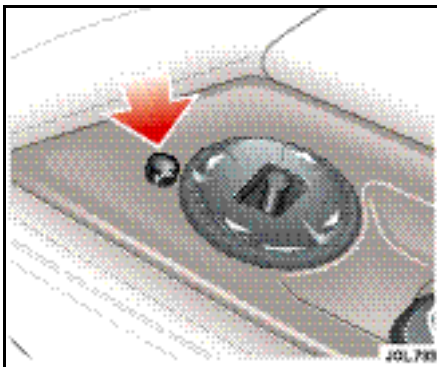

Door mirrors – power fold back

To assist parking by reducing the overall vehicle width, the door mirrors can be folded inwards.

The switch is located in the driver's door window switchpack and will operate the mirrors when the ignition switch is in any position except OFF.

To fold the mirrors inwards press the button. A second press of the button returns the mirrors to their normal driving position.

Note:

1. Do not attempt to reposition power fold back mirrors manually. Always use the button.
2. Should a door mirror be knocked out of position the mirror head will be loose. To re-engage the mechanism, power the mirror to the foldback position, then outwards to the drive position.

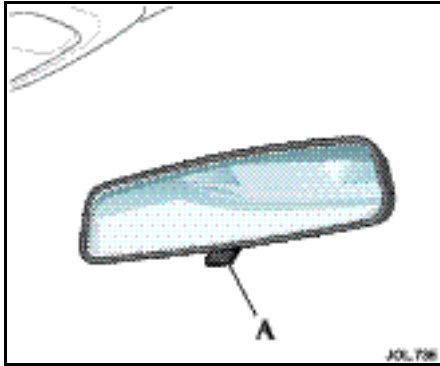

Interior rear view mirror

Interior mirrors are either manual dip or electrochromic.

Interior rear view mirror – manual dip

The interior rear view mirror can be dipped to prevent glare from a following vehicle's headlamps by pulling lever (A). Pushing the lever returns the mirror to its daytime setting.

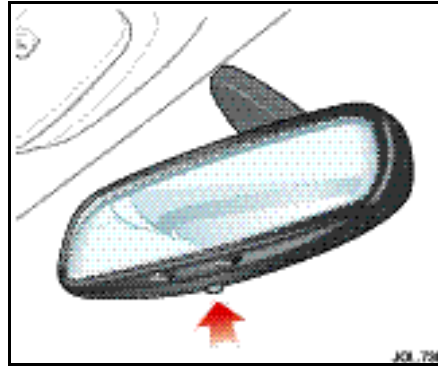

Interior rear view mirror – electrochromic

Push the switch in and the electrochromic rear view mirror darkens automatically to prevent glare from a following vehicle's headlamps. The mirror clears when light levels return to normal. The mirror also clears when reverse gear is selected.

Push the switch again and the glare-reducing effect of the mirror is switched off so that a clear reflection is given.

Note:

1. Should a mirror assembly become detached from the windscreen, it must be refitted by a Jaguar Dealer.
2. Ensure that the windscreen in front of the mirror is kept clean. Where fitted, the moisture sensor for wiper operation is located to the front of the mirror casing. Any dirt may affect the operation of this sensor.

3-20 Before driving

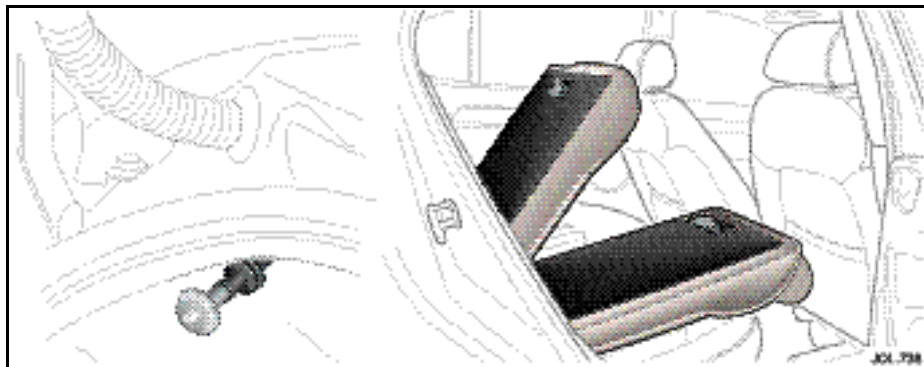

When returning the seat back to the upright position ensure that the seat belts are routed correctly and are not trapped by the seat back. Press the seat back firmly and check that it is locked securely into place.

Luggage compartment



WARNING:

- 1. Locate heavy loads in the luggage compartment towards the front of the vehicle and secure them to stop them sliding. Loose items can be a hazard.**
- 2. Do not drive with the luggage compartment lid open as exhaust fumes can be drawn into the passenger compartment.**

Rear seatback fold down

To provide a longer luggage compartment area, the backs of the rear seat can be folded down in two parts to give a 70/30 width split.

Release handles for each seat back are in the luggage compartment under the parcel shelf.

Pull the selected side handle to release the seat back and then fold it onto the seat cushion.

Ensure when folding the seat back down that the armrest is stowed and that there is sufficient clearance between the seat back, including the headrest, and the back of the front seat.

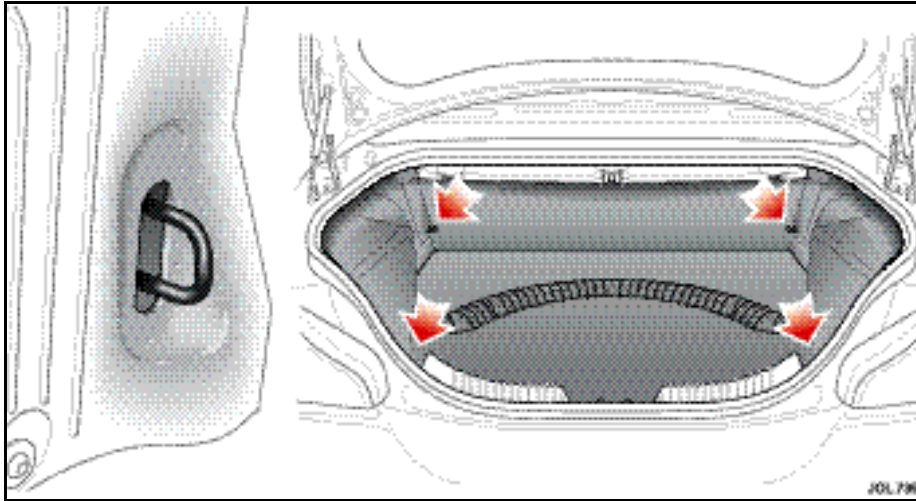

Luggage tie-down loops

Four metal loops are positioned in the luggage compartment for attaching straps to secure loads and prevent them from sliding over the luggage floor.

These loops are not to be used for securing passengers or animals nor as anchorages for child restraints.

A range of Jaguar storage accessories, including a luggage retaining net, are available from your Dealer.

It is advisable to distribute luggage weight evenly over the entire luggage floor area, particularly to prevent permanent damage to the seat trim when a seat has been folded down.

3-22 Before driving

Ski hatch

A two-door hatch is fitted to the rear seat which, when open, gives a space for skis or similar objects to be stowed in the vehicle. Both doors have a single catch.

The inner door is accessible after folding down the armrest. To open the door, press the catch (A) downwards and gently lower the door on to the armrest.

A bag for retaining the skis can now be pulled from the receptacle into the passenger compartment, and the strap (C) loosened ready to accept the skis.

The other door is accessible from inside the luggage compartment and is opened by pushing the catch (B) and lowering the door.

Push the skis into the bag from the luggage compartment and then secure the skis using the strap provided on the bag. Clip the strap connector (D) to the centre rear seat belt buckle.

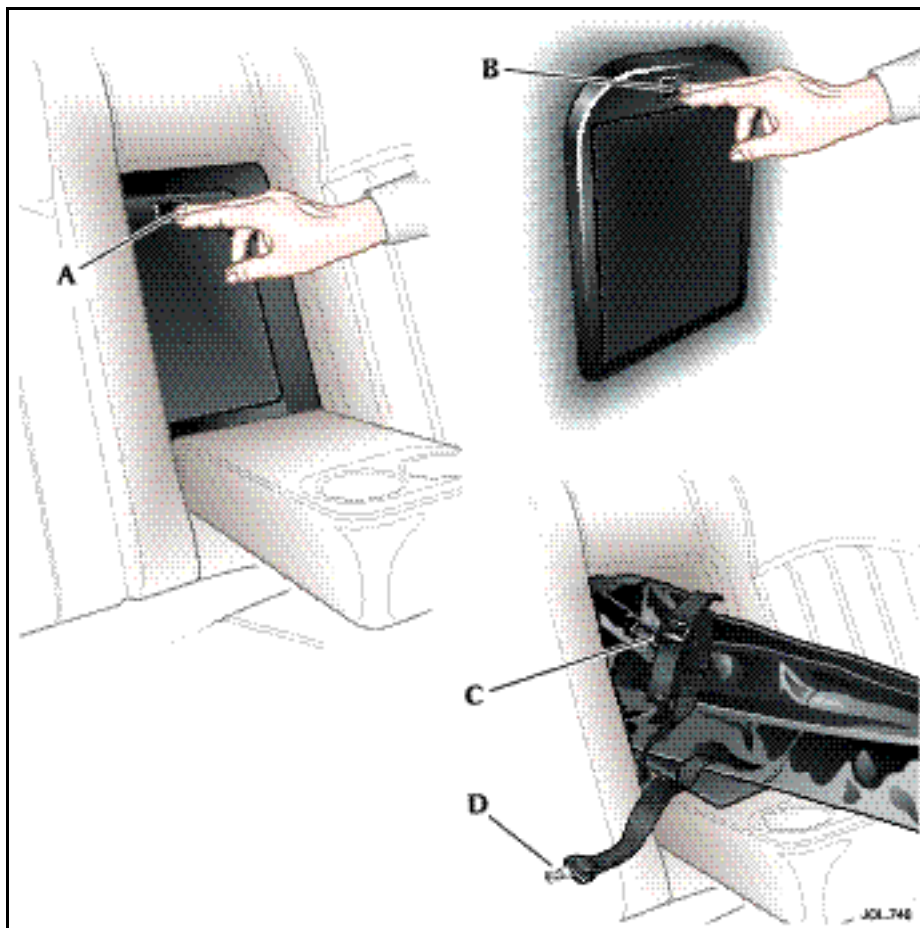

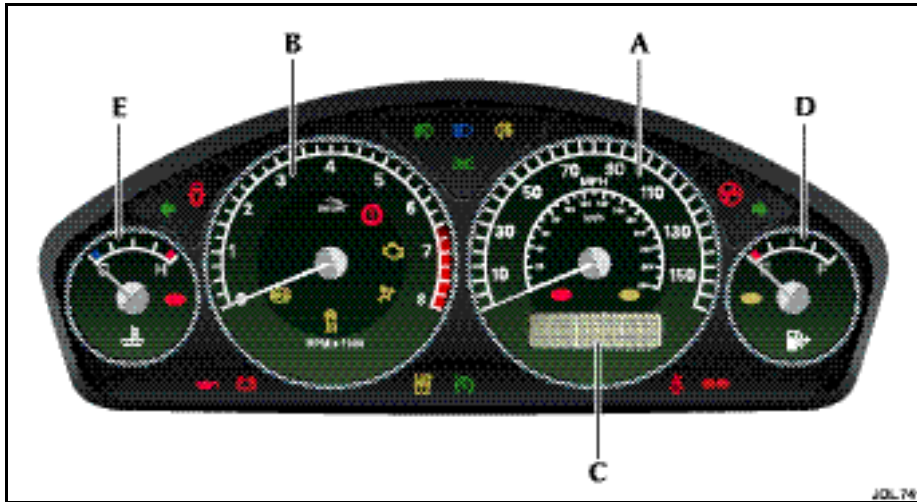

Odometer (C)

Records the total distance covered by the vehicle.

The odometer reading is displayed below the speedometer, along with the trip distance since it was last reset. To reset the trip distance, press the mode button on the end of the left column stalk switch. The trip distance will roll-over at 999.9miles (or 999.9kilometres).

If the vehicle has a message centre then the odometer is displayed in the message centre unless a message has priority or a trip computer function has been selected. The trip distance will roll-over at 9999.9miles (16090kilometres).

Fuel level gauge (D)

Indicates the amount of fuel in the tank. The red warning light illuminates as a low fuel reminder.

The small arrow, shown beside the fuel pump symbol, identifies on which side of the vehicle the filler cap is located.

Instruments

None of the instruments will show correct indications until the ignition is switched ON (position 'II').

Speedometer (A)

Speed indication is in either:

- miles per hour, the outer figures, and kilometres per hour or,
- kilometres per hour, the outer figures, and miles per hour or,
- kilometres per hour only.

Tachometer (B)

The tachometer indicates engine speed in revolutions per minute and is calibrated in increments of 250 extending to 8000 rev/min.

Caution: Do not allow the needle to enter the red sector.

4-2 On the road

Engine Temperature (E)

Drive at moderate road and engine speeds until normal operating temperature is reached. This is indicated when the pointer is between the blue(cold) segment and the red(hot) segment.

The engine operating temperature will vary with changes in weather and engine load. The engine temperature may rise in some circumstances, such as:

- idling for long periods in slow moving traffic.
- driving up a long hill in hot weather.
- driving slowly or stopping after driving at high speed.
- towing a trailer or caravan.

Should the pointer move into the red segment (**H**) or the red light illuminate, stop the vehicle as soon as it is safely possible, turn off the engine and open the bonnet to allow the engine to cool.



WARNING:

The radiator cooling fans may continue to run after the ignition has been switched off but will automatically switch off when the engine has cooled sufficiently.

Warning lights

Warning lights are arranged within the instrument cluster.

When a message centre is fitted there are two warning lights, one red, the other amber, located above the message centre for primary and secondary status of the warnings displayed by the message centre.

‘RED’ warning lights are for primary warnings. A primary warning must be investigated immediately by the driver or a Jaguar Dealer.

‘AMBER’ warning lights are for secondary warnings when the driver must take action and then report the fault to a Dealer at the earliest opportunity.

Other lamps indicate system status, such as blue for main beam and green for direction indicators, when in operation.

A lamp check is initiated when the ignition is switched ON and lasts for three seconds (excepting the airbag warning light which will remain on for 6 seconds). If any warning light remains on after this period, investigate the cause before driving.

When activated, some warning lights have associated messages displayed on the message centre.

Note:

1. Not all lamps are included in the lamp check, for example main beam headlamps or direction indicators.
2. Some lamps will remain lit until the engine is started, for example, engine oil pressure.



High engine temperature



WARNING:

It is unsafe to run the engine in an overheated condition.

The first indication of high engine temperature will be the needle entering the RED zone of the coolant gauge and the illumination of the engine over temperature warning light.

If driving, pull to the side of the road and stop the engine when it is safe to do so. Allow the engine to cool.

To assist cooling, high engine temperature automatically turns off the air conditioning. To maintain some cooling it is advisable to switch the air distribution to 'recirculation'.

If a message centre is fitted the light will illuminate and a message will be displayed.



WARNING:

Do not remove the coolant reservoir filler cap while the engine is hot. If it is essential, then protect your hands against escaping steam. SLOWLY turn the cap anti-clockwise to allow the steam pressure to escape completely before removing the cap.



Low oil pressure

This illuminates with the ignition switched ON and should be extinguished when the engine is running.

If the warning light stays ON when the engine is running, loss of oil pressure is indicated. STOP the engine immediately and investigate the cause.

Caution: Do not restart the engine until the cause of loss of oil pressure has been identified and rectified.

First check the engine oil level, see Section 7.

4-4 On the road



Charge indicator

Illuminates when the ignition is ON and should be extinguished when the engine is running.

If the light stays ON when the engine is running it indicates that there is an alternator fault.

Turn OFF all electrical accessories, radio, climate control, rear screen heater etc.

Try to use the minimum electrical load as possible such as power windows, electric sunroof etc.

Report the fault to a Jaguar Dealer.



Door ajar warning

Illuminates if one or more doors or the bonnet or luggage compartment lid are open.

If a message centre is fitted the light will not illuminate but instead a message will be displayed.



Seat belt

Illuminates for 60 seconds when the ignition is ON and the driver's seat belt is not fastened. If the warning light stays ON with the seat belt fastened, report the fault to a Jaguar Dealer. It is safe to drive the vehicle with the light ON, provided that the seat belt is properly fastened.

Ensure that all occupants seat belts are fastened before driving.



Brake

Illuminates when:

- the ignition is ON and the handbrake is applied
- the brake fluid is low
- there is a fault with the electronic brake system with the ABS light illuminated.

If the light is ON with the handbrake NOT applied, low brake fluid or a fault with the electronic brake system is indicated. In this case, there may be a loss of braking assistance in one, or both, brake circuits. If the light is ON with the ABS light also ON then the electronic brake system may not function correctly, which can impair stability when the brakes are applied.



WARNING:
DO NOT drive the vehicle until the fault is rectified. Consult a Jaguar Dealer immediately.



Anti-lock braking system (ABS)

If a fault has been detected in the anti-lock brake system (ABS) this light will illuminate. The brake system will continue to function normally, but without ABS braking.

Should the light come on or stay on after the bulb check cycle, stop the vehicle at the first opportunity, turn the engine OFF and then restart.

If the ABS light comes on again, the vehicle should be driven to a Jaguar Dealer at the earliest opportunity.



Traction control/DSC

The light will flash at the rate of twice a second when traction control/DSC is operating.

The light is ON continuously when a fault is detected in the system or the system is turned OFF.

If a message centre is fitted the light will not illuminate but instead a message will be displayed.



Engine malfunction

This lamp illuminates when there is an engine malfunction.

Specialised diagnostic equipment is required to repair such faults. Report the fault to a Jaguar Dealer.

The vehicle may go to 'limp home' mode, with the possibility of reduced engine performance. Drive the vehicle with caution.



Powertrain malfunction

Illuminates when there is an engine malfunction or transmission system malfunction.

If a message centre is fitted the light will not illuminate but instead a message will be displayed.



Cruise (Speed) control activated

Illuminates when cruise control is switched ON.

If a message centre is fitted the light will not illuminate but instead a message will be displayed.

4-6 On the road



Airbag

If the airbag system develops a fault, the warning light will flash and then remain illuminated until the fault has been diagnosed and cleared.

Report the fault to a Jaguar Dealer immediately.

It is safe to drive the vehicle; however, in an accident the airbags may not operate.



Side (Parking) lamps

Illuminates when the side (parking) lamps are switched ON.



Main beam

Illuminates when the main beam headlamps are switched ON or flashed ON.



Front fog lamps

Illuminates when the front fog lamps are switched ON.



Rear fog lamps

Illuminates when the rear fog lamps are switched ON.



Direction indicators

The appropriate indicator tell-tale will flash when the column switch is moved up or down to signal a right or left-hand turn. If a direction indicator fails, the tell-tale will flash at twice normal rate when that indicator is selected. Fit a new bulb immediately.

Note: If a bulb has failed, the audible ticking will sound at twice the normal rate.

Hazard warning lamps

When the hazard warning is selected, both direction indicator tell-tales flash simultaneously.



Low washer fluid level

Illuminates when the washer fluid level is low.

If a message centre is fitted the light will not illuminate but instead a message will be displayed.



Low fuel reminder

An amber lozenge in the fuel gauge illuminates when the fuel level is low.



Overspeed warning (Gulf Coast Countries only)

Illuminates if the vehicle speed exceeds 120km/h.

4-8 On the road

Audible warnings

Various sounds are produced for warning and notification purposes as follows:

Hazard or Condition	Remedy/chime or tone
External lamps remain ON when the driver's door is opened.	A chime will sound until the lights are switched OFF or driver's door is closed. Note: The chime will not sound if the switch is in Autolamp position.
Hazard warning indicators ON.	A ticking will sound until the hazard indicators are switched OFF.
Left or right direction indicators ON.	If the switch has not turned itself OFF, switch the turn indicator OFF when the manoeuvre is completed. A ticking will sound until the indicators are switched OFF.
Entry delay warning.	A ticking warning will sound. Disarm the alarm system within 15seconds by placing a key in the ignition switch and turning to position 'I' or press the key transmitter unlock button.
Airbag system failure.	A tone sequence is repeated five times. Report the fault to a Jaguar Dealer as soon as possible.
Seat belt reminder (Gulf Coast Countries and Japan only).	A chime will sound until the driver's seat belt is fastened or the ignition switch turned to 'O'.
Automatic gear selector lever not in Park(P).	When the ignition key is turned from position 'II' to position 'I' a chime will sound for 10seconds or until the lever is moved to Park.
Key in ignition warning.	A ticking will sound until either the key is removed, the driver's door is closed or the ignition switched ON.

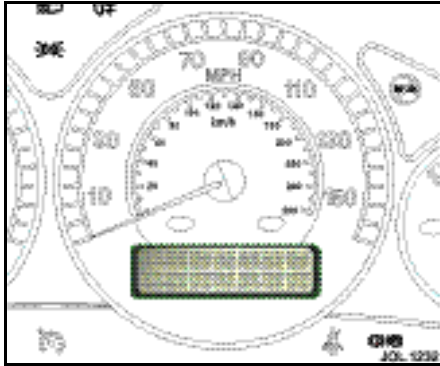

Message centre

Driver information, messages and data are displayed on the message centre display panel situated within the instrument cluster, when fitted.

For the message centre to operate the ignition must be switched ON (position 'II').

The message centre displays:

- the total distance covered by the vehicle.
- trip computer information.
- warning messages if system faults are detected.
- status messages to indicate changes in state of certain vehicle functions.

Messages



WARNING:

If a red warning light is displayed, stop the vehicle as soon as possible but only when it is safe to do so.

The primary function of the message centre is to inform the driver of the following:

- warning messages.
- temporary alert messages.
- Information messages.

Most messages, when displayed, have an associated warning light, red or amber, above the display which will come on to indicate the message priority.

If more than one message is active, each is displayed in turn for two seconds in order of priority.

Note: Messages take priority over the odometer reading or trip computer data and, if active, will be displayed when the ignition is switched ON.

Message centre illumination

The message centre is lit at all times when the ignition is ON.

All information displayed will be brightly lit if the exterior light switch is OFF.

If the exterior light switch is ON the display brightness can be varied using the dimmer switch.

Note: Warning lights and warning messages are always brightly lit and are not affected by the dimmer switch.

4-10 On the road

Messages

The tables on this and the following pages list all messages and warning lights and explains their meaning.

Message	Warning Light	Priority Indicator	Meaning
LOW BRAKE FLUIDLEVEL	Brake	Red	Displayed when the brake fluid level is low. Complete loss of braking may occur.
HIGH ENGINE TEMPERATURE	Engine Overtemp	Red	Displayed when engine temperature becomes excessive. Pull off the road when safe to do so and allow the engine to cool.
RESTRICTED PERFORMANCE	None	Amber	This will be displayed when the vehicle has possible loss of power or driveability. Report the fault to a Jaguar Dealer.
ENGINE SYSTEM FAULT	Malfunction Indicator lamp	Red	Displayed when the engine has defaulted to 'limp-home' mode. Report the fault to a Jaguar Dealer at the earliest opportunity.
GEARBOX FAULT	None	Amber	It is likely that the driver will experience a degradation of gearbox operation.
TRACTION CONTROL FAULT	Traction Control	None	Displayed when a fault occurs in the traction control system.
TRACTION CONTROL ON orOFF	Traction Control	Amber (OFFonly)	Displayed when the traction control system is switched ON or OFF. The warning light will FLASH when the traction control system is switched ON and operating. When the system is switched OFF, the warning light in the instrument cluster will be illuminated until the system is switched back ON.

Message	Warning Light	Priority Indicator	Meaning
STABILITY CONTROL FAULT	Stability Control	Amber	Displayed when a fault occurs in the stability control system.
STABILITY CONTROL ON or OFF	Stability Control	Amber (OFF only)	Displayed when the stability control system is switched ON or OFF. The warning light will FLASH when the stability control system is switched ON and operating. When the system is switched OFF, the warning light in the instrument cluster will be illuminated until the system is switched back ON.
DRIVER'S or PASSENGER'S FRONT OR REAR DOOR OPEN	Door Ajar Warning	Red	Check that all doors are closed before driving.
BOOT OPEN	Door Ajar Warning	Red	Check that the luggage compartment lid is closed before driving.
BONNET OPEN	Door Ajar Warning	Red	Check that the bonnet is closed before driving.
LOW WASHER FLUID LEVEL	Low washer fluid level	Amber	Replenish the washer fluid at the earliest opportunity.
CRUISE CONTROL FAULT	None	Amber	Displayed when a fault has occurred in the cruise control system.

4-12 On the road

Message	Warning Light	Priority Indicator	Meaning
CRUISE CONTROL ON or OFF	None	None	Displayed when cruise control is switched ON or OFF.
LOW OUTSIDE TEMPERATURE	None	Red	Frost or ice likely to form on road surfaces.  WARNING: Even if the message is not displayed there is no guarantee that at low temperatures the road is free from ice.
SECURITY FAILED	None	Red	Displayed when a fault is detected in the security immobiliser system. The alarm security light in the centre console will flash. It is possible that the engine will not start. Report the fault to the nearest Jaguar Dealer.
CHECK FUEL FILLER CAP	None	Amber	The fuel filler cap may be loose or leaking excessively.
LISTENING	None	None	When Voice Activation has been selected and the system is waiting for a voice command/input.

Trip computer

The computer memory stores data for a journey or series of journeys until it is reset to zero.

The displayed information is for guidance only, as it can be affected by traffic, road and weather conditions.

Two independent memories are available (A and B) to allow two separate journeys to be recorded concurrently, for example, work usage and evening/weekend usage.

Trip distance, average fuel economy and average speed will be prefixed A or B depending on the current memory selected.

Press the TRIP button on the end of the left column stalk switch repeatedly to display the data in the following order:

- odometer
- trip distance
- distance to empty
- average fuel economy
- average speed
- messages

Odometer

The odometer shows the total vehicle distance travelled since the vehicle was new.

When the ignition is switched ON (position 'II') the display shows the odometer and trip distance readings.

The odometer reading is displayed in either miles or kilometres, depending on the units selected with the trip computer.

Trip distance (A/B)

Distance travelled since the last memory reset. The maximum trip reading is 9999.9 miles (16093.4 kilometres). The computer will automatically reset to zero if this distance is exceeded.

Distance to empty

Predicted distance, miles or kilometres, that the vehicle should travel on the remaining fuel, assuming average fuel economy and fuel consumption stay constant.

Average fuel economy (A/B)

The average fuel consumption, miles per gallon or litres per 100 kilometres, based on the accumulated distance travelled and the accumulated fuel used.

Average speed (A/B)

The average speed since the last press of the reset button.

4-14 On the road

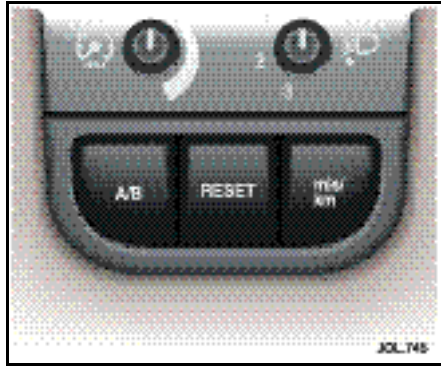

Trip computer switchpack

mls/km

Pressing the 'mls/km' switch alternately displays data in metric or imperial units.

A/B

Selects either A or B trip memory. Select the required data using the column stalk TRIP button and then pressing A/B will show the A or B information for that data.

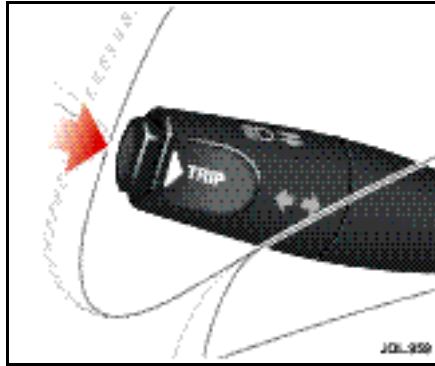

RESET

RESET resets the selected trip to zero.

Warning and Information messages have priority over trip data and, if active, will be displayed when the ignition is at position 'II'.

Note: If warning messages are hidden, the warning/fault still exists and requires investigation.

It also can be used to cycle through:
TRIP-ODOMETER-MESSAGES.

Setting the trip computer

At the start of the journey or series of journeys to be recorded, reset the computer memory to zero as follows:

1. Press the TRIP button on the end of the left column stalk switch to select a trip function. The computer will display either TRIP A: or TRIP B: data.
2. Press the A/B switch to select the trip (A or B) to be reset.
3. Press the RESET switch and hold for 3 seconds.

The display will read:

RESETTING

TRIP A (or B)

then it will reset and display:

A: 0 (or B: 0) or the new value.

Note: All trip functions, for A or B depending on which was selected, will be reset.

Clearing messages

Messages can be hidden by pressing RESET on the trip computer switchpack. One press will hide one message. Once all messages have been hidden, the display will show trip data, a further press will display the odometer reading.

If RESET is pressed again, all active messages will be 're-displayed'. Repeatedly pressing the RESET button will cycle through the trip, odometer and message modes.

If a fault occurs when in trip computer or odometer mode, the relevant message will be displayed immediately.

If a trip computer function is selected by pressing the TRIP button while messages are displayed, the trip data will be displayed for 10 seconds, then the message will reappear.

Hidden messages reappear after an ignition OFF/ON cycle, if the fault remains.

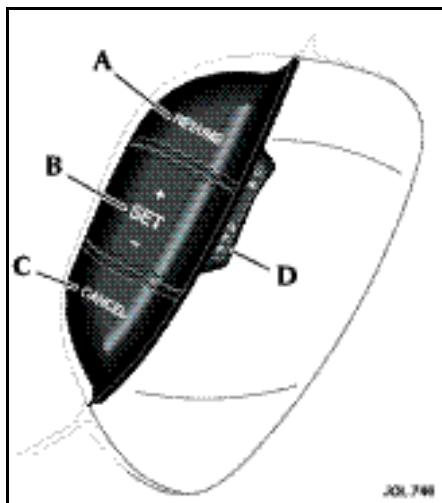

Cruise (speed) control

The cruise (speed) control system, when fitted, can be used by the driver to maintain a selected vehicle speed above 25 mph (40 km/h) without the driver having to use the accelerator.

Illuminated switches on the steering wheel allow the driver manual control of the system. Brake and clutch operation also influences the cruise control system.

(A)– RESUME to resume the set speed retained in memory.

(B)– SET to set the speed or increase/decrease the set speed when the speed has been set.

(C)– CANCEL cancels cruise control but retains the set speed in memory.

(D)– ON/OFF readies cruise control for speed setting or turns cruise control OFF.

Setting vehicle speed



WARNING:

Only use cruise control when conditions are favourable, for example, straight, dry, open roads with light traffic.

To engage cruise control, press the ON/OFF switch and the warning lamp on the instrument cluster will be illuminated to show that the system is ON. Vehicles with a message centre will have the message CRUISE CONTROL ON.

When you are travelling at the speed you require, which must be above 25 mph (40km/h), press the SET button.

Cruise control will engage and maintain the set speed and you can remove your foot from the accelerator pedal.

Note: Cruise control will automatically disengage when the brake pedal is pressed or when the vehicle speed falls below 25 mph (40km/h). If the vehicle has a manual gearbox, pressing the clutch pedal will also disengage the cruise control.

Changing the set speed

There are three ways to change the set speed:

1. Accelerate or decelerate to the desired speed then press the SET(+) button.
2. Increase or decrease the speed by pressing and holding either SET(+) or(-) until the desired speed is obtained, then release the switch.
3. Increase or decrease the speed in steps of 1 mph (2km/h) by briefly pressing either the SET(+) or(-) until the desired speed is obtained.

Resuming the set speed

If the vehicle is accelerated above the set speed, then the set speed will be resumed when the accelerator pedal is released.

If CANCEL is pressed, or the brake or clutch pedal is pressed, the cruise control will disengage but the set speed memory will be retained. Press RESUME and the vehicle will return to the set speed.

Note: Cruise control will not resume at speeds below 25 mph (40km/h).

RESUME will not operate if the ON/OFF switch has been pressed to switch the system off or if the ignition has been turned off.

Caution:

1. **RESUME should only be used if the driver is aware of the set speed and intends to return to it.**
2. **It is not recommended to resume set speed when a low gear is selected as excessive engine speeds will occur.**

Cruise control will switch off and clear the memory when:

- The ON/OFF switch is set to OFF. The warning light in the instrument cluster will go out. A message CRUISE CONTROL OFF will be shown in the message centre.
- The ignition is switched to position '0'.
- A fault occurs. The cruise control system will switch OFF and cannot be used until the fault is cleared.

Cruise control automatic switch off

Cruise control will switch off but the set speed will remain in the memory when:

- The CANCEL button is pressed.
- The brake pedal is pressed.
- The handbrake is applied.
- Speed falls below 25 mph (40km/h).
- Neutral, Park or Reverse gear positions are selected.
- Traction control or DSC is operating.
- The difference between the actual and set speed is too great.
- When the vehicle reaches a maximum speed of:

Manual	125 mph (200km/h)
Auto	120 mph (192km/h)
- The accelerator pedal is used to accelerate beyond the set speed for too long a period.
- If the vehicle has a manual gearbox, pressing the clutch pedal will also disengage the cruise control.

4-18 On the road

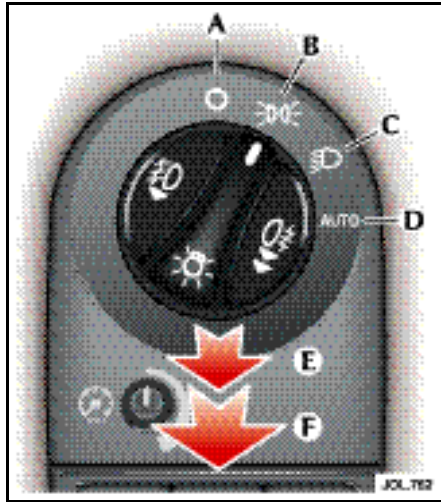

Exterior lighting

Exterior lighting switch

- A. OFF
- B. side (parking) lights
- C. headlights
- D. auto
- E. front fog lights
- F. rear fog lights

The exterior lights are controlled by a rotary light switch mounted on the fascia and by the left-hand column switch.

The rotary switch has up to six positions. These are:

OFF(A) – All exterior lights OFF (except vehicles provided with daylight running lights).

Sidelights (B) – Switches on front sidelights, tail, number plate and any other marker lights required by local legislation. When the external lights are ON the instruments will also be lit.

Headlights(C) – With the ignition in position 'II', this position switches on dipped headlights in addition to the lights switched on in position(B).

The left-hand column stalk switch has two pull positions. Pulling and releasing the switch to the first position causes the main beam to flash. The main beam can be flashed with the ignition in position 'II' and will remain ON for as long as the switch is held.

The second position is to switch main beam headlights ON. With the ignition in position 'II', first select dipped beam lights (C), and then pull the column light switch past the first position, fully towards the steering wheel.

The blue warning light on the instrument cluster and main beam headlights will come ON.

To turn main beam OFF, pull the column switch again to the main beam position.

Note: If dipped beam is switched OFF, with main beam still activated both dipped and main beam will be extinguished. Both dipped and main beam will illuminate if dipped is turned on again. The ignition must be in position 'II' for the flash to operate.

Headlight convenience

The main beam lights are turned on for 30seconds when the headlight convenience button on the key transmitter is pressed.

Note: The key must not be in the ignition switch for this feature to operate.

The main beam lights can be turned off before the 30second delay by pressing the headlight convenience button on the key transmitter or by turning the ignition to position 'II'.

Auto(D) – A light sensor control, mounted on the front of the interior mirror fixing cover, monitors exterior light levels and automatically switches the sidelights and dipped headlights ON or OFF.

The ignition switch must be in position 'II' for automatic light operation.

When light fades to the non-adjustable, pre-set level, the sidelights and headlights will switch ON automatically.

As light increases to the pre-set level, the sidelights and headlights switch OFF automatically.

Do not cover the sensor and keep the windscreen clean. Obstructing the light in this area may lead to unwanted operation of the sidelights and headlights.

Front fog lights(E)

With the switch in sidelight or dip position, pull the switch to its first position to turn on the front fog lights. Pushing the switch in or turning it to OFF or AUTO will turn off the front fog lights.

Note: The front fog lights should only be used when visibility is severely restricted by fog.

Front fog lights cannot be used with main beam headlights. If main beam headlights are switched on when the front fog lights are on, the front fog lights will be switched off.

The front fog lights will not turn on if they are selected when main beam headlights are on.

Rear fog lights(F)

With the switch in any position except OFF or AUTO, pull the switch to its second position to turn on the rear fog lights. This will also turn on the front fog lights unless main beam is selected. Pushing the switch in or turning it to OFF or AUTO will turn off the rear fog lights.

Daylight running lights

In certain countries it is a legal requirement for the lights to be on during the hours of daylight.

With the rotary light switch in the OFF position(A), dipped headlights, sidelights, tail, number plate lights and, (where fitted), side marker lights will switch on automatically with the following conditions:

- the ignition is turned to position 'II',
- the vehicle gear selector out of park (automatic transmission only)
- the handbrake not applied (released).

4-20 On the road

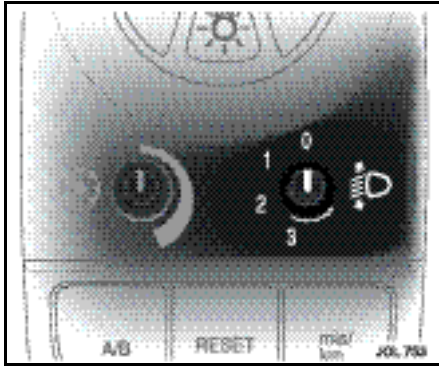

Auto headlight levelling

Automatic levelling of the High Intensity Discharge (HID) headlights is a feature which avoids dazzling oncoming drivers. A control unit adjusts the height of the lights during acceleration, deceleration and terrain variation.

Headlight levelling

The headlight levelling switch operates when the headlights are switched ON. Push and release the knob to extend it for ease of operation. Push the knob again to place it in the stowed position.

Turn the knob to the setting appropriate for the vehicle load, for example:

- '0' Normal setting– Driver only.
- '1' Driver and one front passenger.
- '2' All seats occupied and maximum luggage.
- '3' Fully loaded vehicle and towing a caravan or trailer.

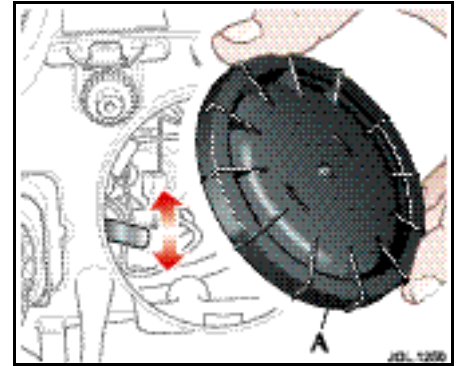

Touring headlight adjustment

When touring in countries where driving is on the other side of the road to your country, your vehicle dipped beam lights may dazzle oncoming drivers.

A lever, within the main beam headlight, is used for dipped beam adjustment for touring. This lever flattens the dipped beam to avoid dazzling oncoming drivers.

Remove the round cover (A) and move the lever upwards to flatten the beam.

Push the lever downwards to revert to normal dipped beam.

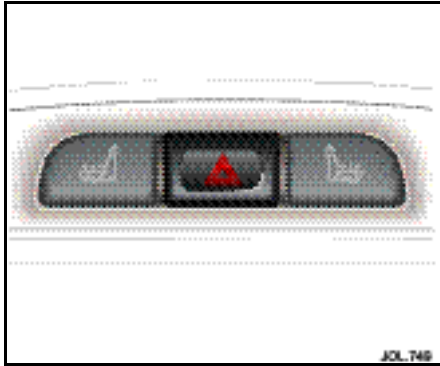

Hazard warning

The switch is in the centre console and operates with the ignition ON or OFF. Use only in an emergency to warn traffic of a vehicle breakdown or approaching danger.

To operate: Press the switch; the direction indicators, the instrument cluster green indicators and audible warning will operate in unison.

To cancel: Press the switch again.

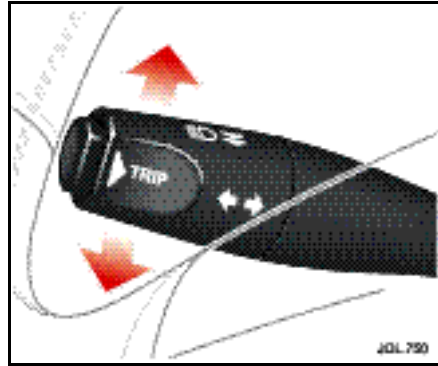

Direction indicators

The direction indicators operate when the ignition is in position 'II'. To indicate for a right or left turn, move the column left stalk switch up or down respectively. The switch will cancel when the turn is completed.

An audible ticking and a flashing green arrow on the instrument cluster indicates that the selected direction indicator is ON.

Should a direction indicator bulb fail, the corresponding side green warning light will flash at twice the normal rate. The audible ticking will sound at twice the normal rate.

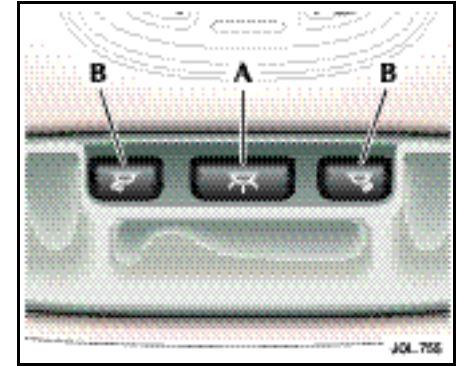

Interior lighting

Interior lighting comprises, front and rear overhead courtesy lights, two front reading/map lights, a rear roof light, and front door puddle lights. Vanity mirrors, glove compartment, footwell and luggage compartment lights are provided.

Press the centre switch (A) in the front roof console to turn the courtesy lamp on. A second press turns the light off.

Reading/map lighting

The reading/map lights are turned on and off by individual switches (B).

4-22 On the road

Illuminated entry/exit

When the vehicle is unlocked the courtesy lights will gradually illuminate and remain on for 25 seconds.

If the courtesy lights are on they will fade off 25 seconds after the last door is closed, or when the vehicle is locked.

Door guard/puddle lamps

Door guard lamps are fitted to each front door to give warning of an open door to passing vehicles. The puddle lamps illuminate the 'step out' area at night.

Luggage compartment lighting

The luggage compartment will be illuminated when the lid is opened.

Glovebox

The glovebox will be illuminated when the lid is opened, provided the sidelights are switched on.

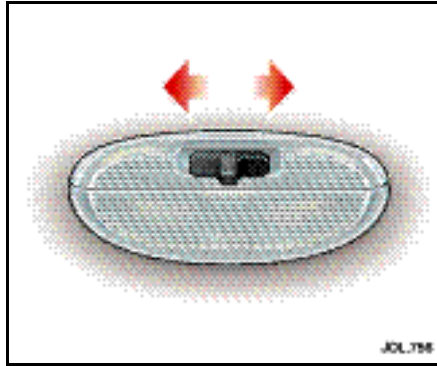

Rear roof light

The rear roof light switch has three positions:

- in the left position the light will come on or go off when a door is opened.
- in the centre position the light will be switched on.
- in the right position the light will be switched off.

Battery saver

If the interior lights are switched on using the centre switch in the overhead console and the ignition switch is turned to positions '0' or '1', the lights will automatically turn OFF after 30 minutes.

If the interior lights are switched on by a opening a door and the ignition switch is in positions '0' or '1', the lights will automatically turn off after 10 minutes.

If the glove compartment, puddle or vanity lights are switched on and the ignition switch is turned to positions '0' or '1' or the key is removed, the lights will automatically turn OFF after 30 minutes.

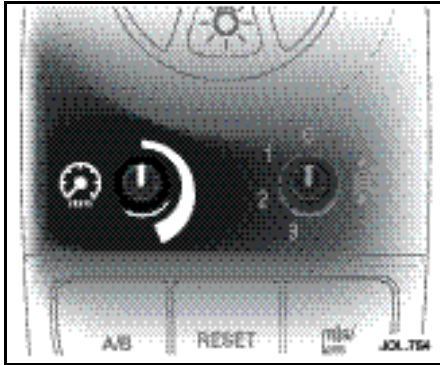

Dimmer switch

The instruments, door switch packs, in-car entertainment panel and the climate control panel will be lit when the ignition switch is in position 'II'.

Push and release the knob to extend it for ease of operation.

Rotate the knob to adjust the illumination to the required level.

Push the knob again to place it in the stowed position.

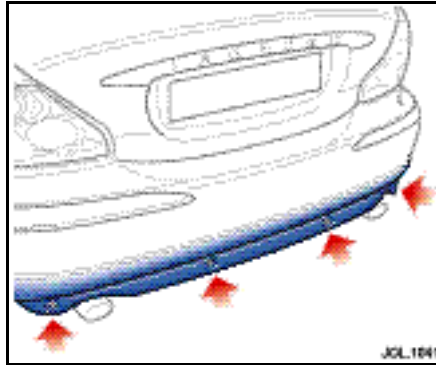

Reverse park control

Caution: It remains the driver's responsibility to detect obstacles and estimate the car's distance from them. Some overhanging objects, barriers, thin obstructions or painted surfaces which could possibly cause damage to the vehicle may not be detected by the system. Always be vigilant when reversing.

This parking aid, when reverse gear is selected and ignition on, automatically provides an audible proximity warning when reversing the vehicle. If an object is detected, a beep tone will be heard, which increases in rate as the vehicle approaches the object.

At approximately 8 inches (200mm) the beep will become continuous for three seconds and is then automatically turned off.

Reverse park control is automatically switched off if a trailer is attached to the vehicle.

If the system has a fault when engaging reverse gear then a single, three second tone only will be heard

Note:

1. For reliable operation, the four sensors in the rear bumper should be kept free from ice and grime.
2. When using a high pressure spray the sensors should only be sprayed briefly and not from a distance of less than 8 inches (200 mm).

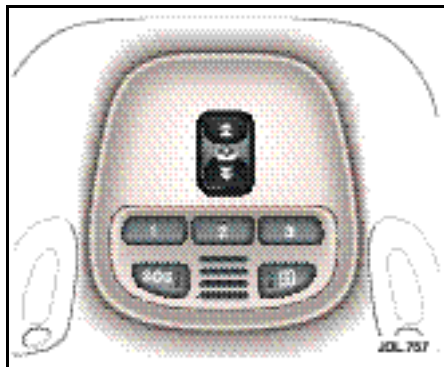

Sunroof



WARNING:

1. **Before opening or closing the sunroof check that all occupants are clear.**
2. **When leaving the vehicle take the ignition key to prevent misuse of the sunroof switch by remaining occupants, especially children.**

The sunroof switch is located in the overhead console. The ignition switch must be in position 'II' for the sunroof to operate.

To open the sunroof:

- push the rear of the switch gently upwards to the first position and hold until the sunroof is fully open. The sunroof can be stopped at any open position by releasing the switch.
- To fully open the sunroof with one touch operation, briefly push the rear of the switch fully upwards to the second position and then release. To stop the sunroof opening, briefly press the switch upwards, forwards or rearwards.

To close the sunroof:

- push the front of the switch upwards to the first position and hold until the sunroof is closed. It can be stopped at any position by releasing the switch.
- To close the sunroof with one touch operation, briefly push the front of the switch upwards to the second position and then release. To stop the sunroof closing, press the switch upwards, forwards or rearwards.

To tilt the sunroof open:

push the front of the switch upwards and hold until the required position is reached, or until the tilt is fully open, and then release the switch. To tilt open with one touch operation, briefly push the switch upwards to the second position.

To close the tilted sunroof:

push and hold the rear of the switch until the sunroof is closed. Briefly push the rear of the switch upwards to the second position to tilt closed with one touch operation.

Sunshade operation

The sunshade can be manually opened and closed using the pull cup. When the sunroof is fully open the sunshade is also fully open and, because the pull cup is hidden, it cannot be manually closed from this position.

Note: If the sunshade is fully open the pull cup cannot be accessed until the sunroof is fully closed.

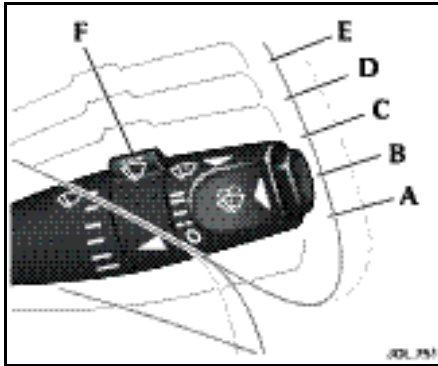

Wipers and washers

The windscreen wipers and screen wash functions are controlled by the right-hand column stalk switch and only operate with the ignition in position 'II'.

Windscreen wipers

The stalk functions are as follows:

Position (A):

Flick wipe.

Position (B):

The windscreen wipers are Off and parked.

First position (C):

Intermittent wipe.

Second position (D):

Slow wiper operation.

Third position (E):

High speed wiper operation.

Intermittent wipe

When intermittent wipe is selected the delay between wipes can be varied. Turn the collar(F) to vary the delay from 1second to 22 seconds.

Flick wipe

Pull the column switch downwards for a single wipe. Holding the column switch in this position will operate the wiper continuously at slow speed until released.

Rain sensitive wiper control

When AUTO, (turn the rotary collar(F) to AUTO) and intermittent wipe is selected, the wipers will automatically operate to clear the windscreen when rain falls on to the windscreen, or when moisture is present.

For the wipers to operate, the ignition switch must be in position 'II'.

Note: When starting a journey with a wet windscreen, the rain sensing wipers will not operate immediately the ignition is switched on, therefore, a flick wipe should be used to clear the windscreen of any moisture.

Caution: Ensure that AUTO is not selected when entering a car wash or damage to the wiper blades/arms can occur.

4-26 On the road

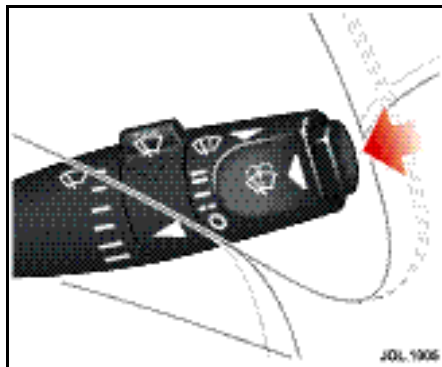

Windscreen wash/wipe

Push the button on the end of the switch to obtain the wash/wipe programme.

If the wipers are selected off or intermittent, the washers will operate at slow speed during the washing action when the button is pressed. When the button is released, the wipers will complete three further wipes.

After the wash cycle has been completed the wipers will pause and then complete a drip wipe to clean any remaining drips of moisture from the screen. If rain sensitive wipers are fitted and selected then the wipers will operate until no moisture is detected. Drip wipe can be turned on or off by a Dealer, if required.

Headlight powerwash

Note: The headlight powerwash units are mounted between the front headlights.

The headlight powerwash feature will operate if the ignition is in position 'II' and sidelights are switched ON. It will not operate if the washer fluid level is low.

When the windscreen wash/wipe button is pressed, the headlight powerwash directs a short burst at the headlights. If the wash/wipe button is held, the screen wash cycle will continue for up to 20seconds.

The headlight powerwash will operate the first time the wash/wipe button is pressed and thereafter every sixth succeeding wash/wipe operation. If the headlights or ignition are switched OFF and ON again, headlight powerwash will operate on the next press of the wash/wipe button.

Note: If the washer fluid level is low in the reservoir the windscreen wipers will not operate when windscreen wash is selected even though there may be washer fluid remaining in the reservoir and sprayed onto the screen. This is to prevent damage to the blades, scratching of the glass or smearing dirt across the screen. Flick wipe can be selected to clear the sprayed fluid from the screen.

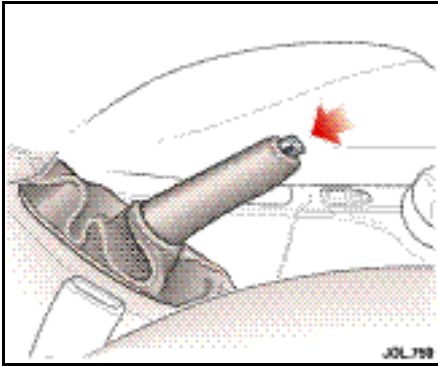

Handbrake

The handbrake lever, which applies the parking brakes, is mounted on the centre console beside the driver's seat.

Pull the handbrake fully upwards to engage the parking brakes. The handbrake warning/brake fluid low warning light on the instrument cluster will illuminate, if the ignition is on.

To release the handbrake, lift the lever slightly, press the locking button at the end of the lever and lower fully.

If the handbrake lever is not fully off, the handbrake warning/brake fluid low warning light will stay on.

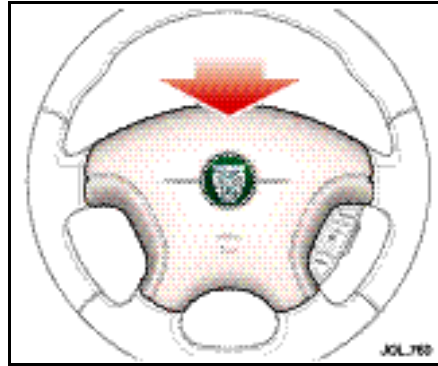

Horn

The dual tone horn is operated by pressing the centre pad on the steering wheel.

The horn also operates as a warning horn if the vehicle alarm system is activated.

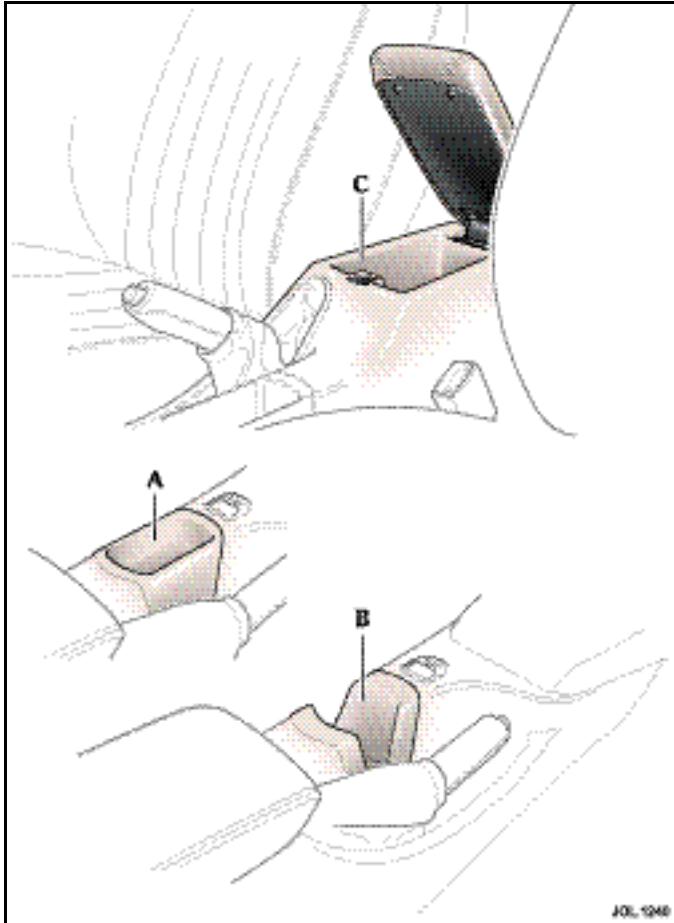

Interior features

The centre console carries the trinket tray(A) or cup holder(B) and the storage compartment and armrest(C).



WARNING:

- 1. Do not place hot drinks in the cup holders whilst the vehicle is moving, there is a risk of scalding.**
- 2. Use soft cups only.**

Lift the front of the hinged armrest to gain access to the cubby box.

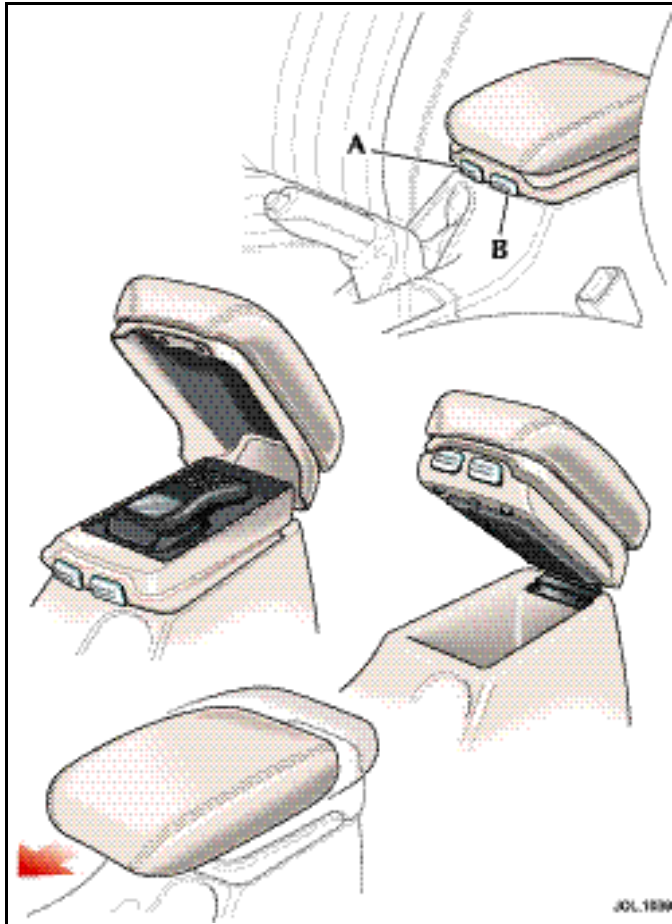

Sliding armrest

The sliding armrest is hinged at the rear and has two release buttons located on the front of the armrest.

Press the right-hand button (A) and lift the top of the armrest to gain access to the top storage compartment, or phone if fitted.

Press left-hand button (B) and lift the complete armrest to gain access to the centre console cubby box compartment.

Pull the top of the arm rest forwards or push rearwards to slide the armrest to a comfortable position.

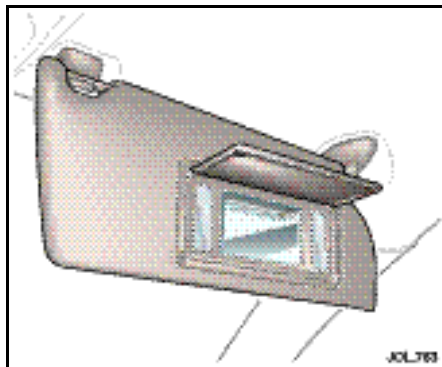

Sun visors and vanity mirrors

Adjustable sun visors can be swung downwards or unclipped and swung sideways to reduce sun glare.

The sun visors are fitted with illuminated vanity mirrors, behind a hinged flap. The light comes on when the flap is lifted.

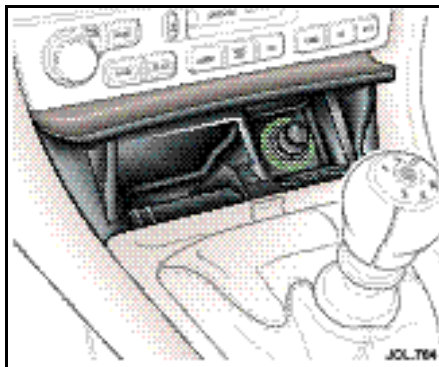

Cigar lighter and ashtray

Push the lid to gain access to the cigar lighter and ashtray.

To operate the cigar lighter the ignition must be on, press the lighter down and wait until the element has heated, it will then pop-up.

Note: Never hold the lighter knob down. Do not attempt to remove particles from the heating element as it is self-cleaning.

To empty the ashtray, lift it out vertically and remove. After emptying, push the ashtray into the opening until it snaps back into place.

An ashtray for rear seat passenger use is fitted to the end of the centre console.

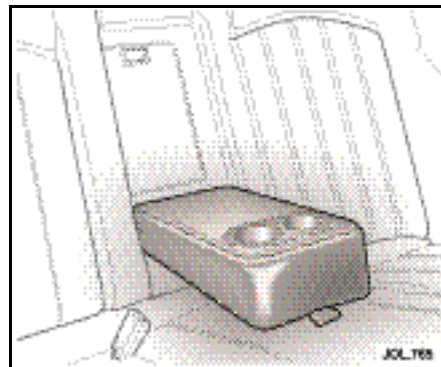

Rear centre armrest

Pull the loop on the rear centre armrest to lower. If not required, raise the armrest to its upright position and push firmly into place. Ensure that the armrest is raised when lowering the seat back to increase the luggage compartment area.



WARNING:

Never have hot liquids in the cup holder whilst the vehicle is moving. If the contents spill, occupants could be scalded. Use only soft cups and cool liquids.

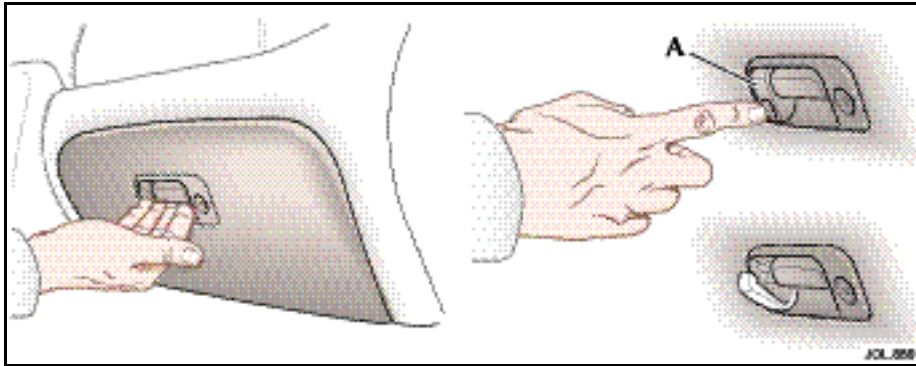

Glove compartment

A glove compartment is located below the passenger's airbag.

To open the glove compartment, lift the handle and allow the lid to drop down. The compartment will be illuminated when open.

If the compartment is left open the lamp will extinguish approximately 30 minutes after the ignition has been set to position '0'.

The glove compartment can be locked using an ignition key.

Light-weight luggage hook

A hook for holding light-weight items such as a handbag, purse or a small shopping bag is fitted beside the glove compartment lid release catch. Press the lower part of the hook (A) to lower the hook. Fold the hook back into the lid after use.

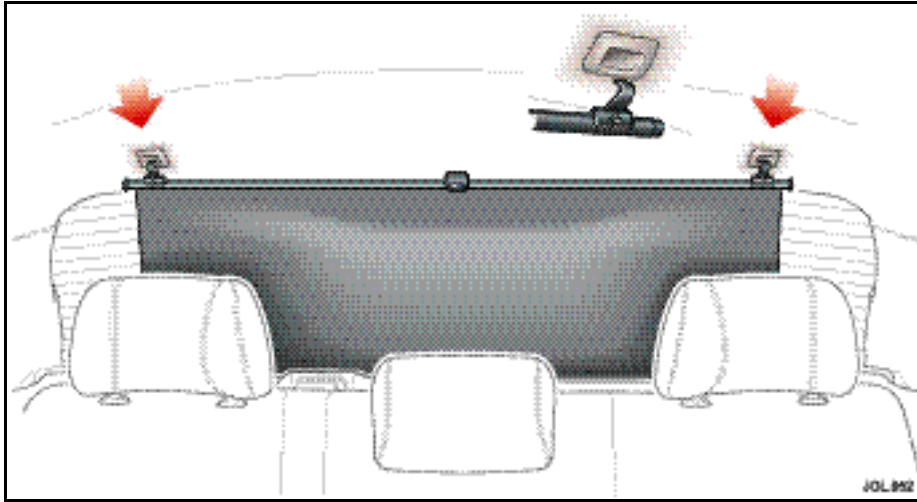

Rear sun blind

The manually operated rear sunblind is fitted to the parcel shelf.

Using the centre lift point, raise the sun blind and engage the two retaining lugs into their holders in the headlining.

To lower the sun blind, holding the centre lift point, carefully disengage the retaining lugs and gently lower the blind into the parcel shelf.

Starting/stopping the vehicle

When the vehicle is stationary the automatic gear selector may be left in 'D', '2', '3' or '4', unless the vehicle is to be parked. When stopping for traffic lights, junctions etc., either select 'P' or apply the handbrake and select 'N'.

Before starting

Before starting the engine, new owners/drivers should familiarize themselves with the layout and operation of the controls and instruments.

To disengage the steering lock



WARNING:

Before attempting to start the engine, check handbrake is ON and gear selector lever (automatic transmission) is in position 'P' or 'N' or (manual transmission) in Neutral.

The engine cannot be started until the gear selector is in 'N' or 'P'. Insert the key into the ignition switch and turn clockwise to position 'II' to switch on the ignition.

To start the engine – automatic transmission

When the key is turned to position 'III' the engine starter will begin to rotate the engine and the key can then be released. The starter motor will continue turning the engine until:

- the engine starts
- a time limit is reached, this is to protect the starter motor from damage
- the ignition switch is turned to '0' or 'I'
- the gear selector is moved out of 'P' or 'N'

If the engine fails to start the key must be turned to position '0' before attempting to restart.

To start the engine – manual transmission

With manual transmission vehicles, do not use the starter continuously for longer than six seconds. Continued use of the starter will discharge the battery and may also damage the starter mechanism. To start the engine, turn the key to position 'III'. When the engine starts, release the key which will automatically return to position 'II'. Wait until the engine stops before re-using the starter.

Note: Do not depress the accelerator pedal whilst operating the starter motor. The red charge warning light in the instrument cluster should go out when the engine is running.

If the engine fails to start

If an ignition key is placed in the ignition switch and turned to position 'II' and the alarm security light is flashing, it is possible that the engine will not start. In any event, please contact a Jaguar Dealer to investigate the cause of the light flashing.

There is also the possibility that the inertia switch has tripped, see Chapter 6.

4-34 On the road

If the engine persistently fails to start and flooding is suspected, depress the accelerator pedal fully, hold it in this position and turn the key to position 'III' for six seconds. Release the key, remove your foot from the accelerator pedal and then attempt to restart the engine.

Note: The engine cannot start whilst the pedal is fully depressed, it must be released to enable the engine to start.

It is possible that the fuel system inertia switch may have tripped, see Section 6 for the resetting procedure.

If the engine still fails to start, switch the ignition OFF and contact a Jaguar Dealer.

To stop the engine and lock the steering

Turn the key from position 'II' to the 'lock' position '0'. This turns off the ignition and stops the engine. The steering will be locked when the key is removed from the switch.

Leaving the key in position 'I' or 'II' will discharge the battery.

Parking the vehicle

When leaving the vehicle, remember the following:

- Whenever the vehicle is being parked, apply the handbrake and, with automatic transmission, move the gear selector to Park 'P'.
- Do not leave children or pets in the vehicle unattended.
- Do not leave luggage or valuables on view. Always take your valuables with you or lock them in the luggage compartment.
- Remove the ignition key and spare keys, even when the vehicle is in your garage.
- When the vehicle is unoccupied, close all windows and lock all doors securely.

- Park the vehicle where it can be seen. At night, park in a well-lit area.
- When leaving the vehicle unattended, for maximum security ensure that the doors are double-locked (where fitted).

Ensure that the keys and the key transmitters are removed from the vehicle before locking the doors, and that all doors, the luggage compartment and the bonnet are closed.

Automatic transmission

The 'J'-gate gear selector lever is designed to accommodate two different driving techniques as follows:

- Automatic selection– the right-hand side of the selector gate.
- Manual selection– the left-hand side of the selector gate to individually select 4th, 3rd, or 2nd gear.

Gear-shift interlock

(automatic transmission only)

A brake pedal/gear-shift interlock system is incorporated in the automatic gear selector mechanism.

To move the gear selector from Park:

1. Turn the ignition key to position 'II' or start the engine.
2. Press the brake pedal.

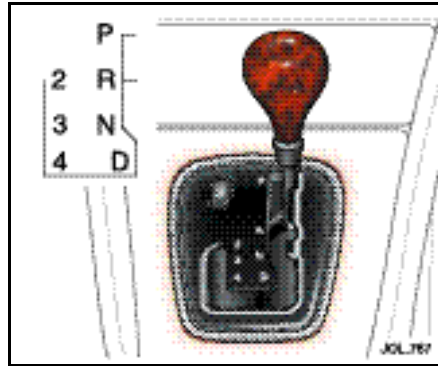

Gear selector positions



WARNING:

The handbrake or brake pedal must be applied before selecting forward or reverse drive from a stationary position.

P = Park– Use when parking. In this position the transmission is locked. Do not select if the vehicle is moving.

N = Neutral– Disconnects the driveline from the engine. Use the handbrake when stopping temporarily.

R = Reverse– Do not select if the vehicle is moving forward.

The reversing lights come ON automatically when reverse gear is selected and the ignition switch is in position 'II'.

D = Drive– All five gears are changed automatically as required by the throttle position and road speed.

2, 3, 4 = Second, third, fourth – If selected, the transmission operates automatically but will not engage gears higher than the one selected.

Note:

1. After selecting forward or reverse drive ranges from Neutral or Park, wait briefly for the transmission to engage before accelerating.
2. When in Neutral or Park the engine can only be accelerated to 3000rev/min automatic transmission or 6000rev/min manual transmission.

Drive to fourth

When driving in gear position 'D' with fifth gear engaged, the gear selector can be shifted sideways across the gate to '4'. Provided that the vehicle's speed is not too great, the transmission will shift down to fourth. Fifth will be inhibited until the gear selector is moved back to 'D'.

4-36 On the road

Hill climbing and engine braking

When driving on roads with long downhill gradients, selecting '3' or '2' (depending on road/traffic conditions) will give engine braking.

When the gear selector is moved from 'D', '4' or '3' down to '2', downshift to second gear will only take place at road speeds below 40 mph (64km/h).

Shift inhibit

Reverse is inhibited when the vehicle is moving forward at speeds above 5 mph (8km/h).

Note: Reverse inhibit will not function in limp home mode.

Kickdown

Kickdown is operated when the pedal is pressed fully down to provide maximum engine performance. Kickdown is used in circumstances where rapid acceleration is required, such as when overtaking.

Kickdown causes the transmission to change down to the lowest gear possible to achieve maximum acceleration. The gear engaged depends on the road speed at the time of kickdown.

As well as shifting down, the gear shift points are extended to give greater performance. This mode is in effect for as long as the pedal is pressed fully down.

Limp Home Mode

In the unlikely event of an electrical or mechanical failure, transmission operation will be impaired. The vehicle gear selector ranges P, R, N, D can still be used to enable the vehicle to be driven to a safe area.

The driver should be aware that the vehicle's performance will be reduced and must take this into account when driving. In this event consult a Jaguar Dealer **immediately**.

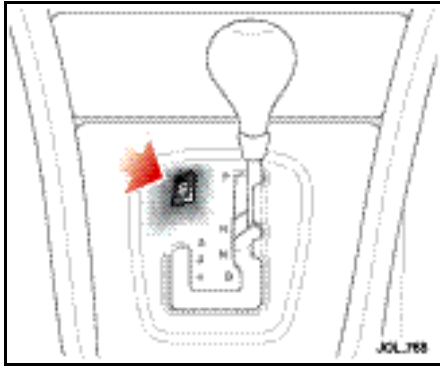

Sport mode

The switch marked 'S' on the 'J'-gate surround enables the driver to select either normal 'N' or sport 'S' modes.

When sport mode is selected the automatic transmission will operate normally, but the gear shift points are extended to make full use of the engine's power reserves.

To select 'Sport', press the switch. A red light within the switch is illuminated to indicate that sport mode has been selected.

To cancel 'Sport', press the switch again.

Note: Both sides of the 'J'-gate can be used irrespective of the transmission mode, e.g. with 'S' selected the transmission can be operated in full automatic or by manual selection.

In addition to the 'switched' transmission modes ('N' and 'S') the transmission control module will select shift patterns to suit specific conditions.

Cruise Control – When cruise control is operating at set speed the transmission selects a shift pattern to suit cruise control operation.

DSC/Traction control – When DSC/traction control is switched ON and the system is activated, the transmission selects a shift pattern to suit traction control conditions.

Gradients – When the vehicle is being driven on roads with uphill gradients, the transmission adapts the shift pattern to make better use of engine power and aid engine cooling.

Note: Under the conditions described above, the relevant transmission mode will override the 'N' or 'S' modes selected by the driver. When such conditions no longer exist, e.g. Cruise Control switched OFF, the transmission will revert to the shift pattern previously selected by the driver, i.e. 'N' or 'S'.

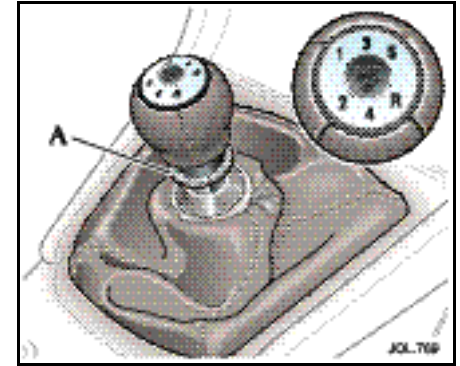

Manual transmission

Gear selector lever

A diagram of the gear shift pattern is set in the top of the lever knob.

Depress the clutch pedal completely when changing gear. To avoid excessive clutch wear do not drive with your foot resting on the clutch pedal.

To select reverse gear, pull up the ring below the gear knob(A), then move the lever to the reverse position.

Caution: Do not select reverse gear while the vehicle is moving forwards.

Anti-lock braking system (ABS)

This system helps to prevent the road wheels from locking and skidding during emergency braking, assisting the driver to maintain full steering and directional stability.

The factor controlling ultimate stopping distance and cornering ability is tyre/road adhesion.



WARNING:

- 1. It remains the driver's responsibility to drive safely according to prevailing conditions.**
- 2. The fact that a vehicle is fitted with ABS must never allow the driver to be tempted into taking risks which could affect his/her safety or that of other road users.**
- 3. The addition of ABS cannot overcome the consequences of trying to stop in too short a distance, cornering at too high a speed, or the risk of aquaplaning.**

- 4. The driver should always take road conditions into account. A slippery road surface always requires more braking distance for a given speed, even with ABS. A possible increase in stopping distance compared to locked wheels may occur during ABS operation on slushy snow, gravel, sand, or some heavily corrugated or ridged warning sections of road surfaces.**

ABS optimises tyre/road adhesion under maximum braking conditions though it cannot provide increased cornering ability. There is no need for special braking techniques, such as 'pumping' the brakes, to achieve optimum braking distances and control on poor or slippery road surfaces. Tyres must be in good condition to achieve maximum adhesion.

During normal braking the ABS will not be activated. However, if the braking force applied begins to exceed tyre/road adhesion the ABS will automatically activate, preventing the road wheels from locking.

In these circumstances a pulsating effect will be felt from the brake pedal indicating that the system is functioning. The pulsating effect is due to small fluctuations in pressure supplied to the brakes by the system to maintain full tyre/road adhesion.

Under severe braking on some road surfaces tyre noise may be apparent even though the wheels will at no time become locked.

ABS monitoring

The ABS control module monitors the ABS electrical system from ignition switch ON to ignition switch OFF. Any malfunction will be indicated by the anti-lock warning light coming on.

Should a fault develop in the ABS system, the brake system will still operate conventionally and with the same standard of performance as vehicles not equipped with ABS.

Caution: Consult a Jaguar Dealer immediately if the warning light comes on while driving, a system failure is indicated.

Advice on ABS braking techniques

For optimum ABS performance these instructions on braking techniques during ABS operation should be followed:

1. Do not release brake pressure when the pulsating effect is felt. Maintain a constant pressure until the manoeuvre is completed.
2. To familiarise yourself with the feel of the brake pedal during ABS braking, practise an emergency stop procedure, always making sure it is safe to do so. With the seat belts fitted to all occupants, drive the vehicle at 20mph (32km/h) and brake sharply.
3. ABS enables the driver to steer around obstacles during emergency braking. However, the consequences of turning sharply at high speed cannot be overcome by the ABS.
4. Do not attempt to 'pump' the brakes to avoid skidding as this can interfere with the ABS operation. The ABS will not allow the wheels to skid under normal road conditions.
5. The ABS will tend to keep the vehicle straight during braking. Because braking distances may increase under certain road conditions, it is necessary to plan and make turning manoeuvres as early as possible.

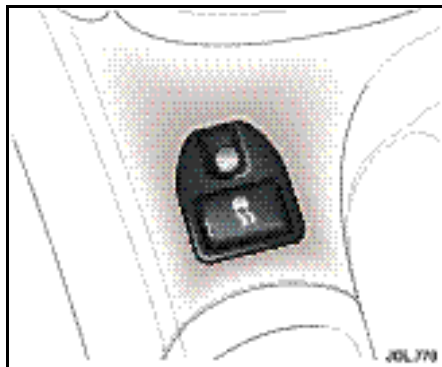

Dynamic stability control (DSC)

DSC is operational whenever the engine is running, unless it has been switched off. If the system is operating, the warning light in the instrument cluster will flash.

The DSC system controls the anti-lock braking system (ABS), traction control and yaw control of the vehicle.

Yaw control determines the vehicle's direction relative to the driver's inputs (sideslip and under/oversteer). It applies braking pressure to individual wheels if excessive variation is detected. This ensures that the vehicle follows the driver's intended direction of travel.

The system will intervene to prevent wheel spin, by automatically reducing the power output from the engine and applying braking to individual wheels.

This improves acceleration, particularly on surfaces with uneven friction, for example, one wheel on ice the other on tarmac.

The dynamic stability control system can be switched OFF by pressing the switch on the centre console. The warning light in the instrument cluster will remain on and, if fitted, a message will be shown to indicate that the system has been switched OFF. If the switch is pressed again the system will switch ON.

Note: If cruise control is engaged it will automatically disengage if stability control activates.

If a message centre is fitted, a system malfunction is indicated by the message:

STABILITY CONTROL FAULT

Warning light: Amber

For all vehicles, the instrument cluster warning light will be lit.

It is safe to drive the vehicle but the system may not activate under wheel spin or slide conditions. Report the fault to a Jaguar Dealer as soon as possible.



WARNING:

1. **The fact that the vehicle is fitted with Stability Control must never allow the driver to be tempted into taking risks which could affect his/her safety or that of other road users. In all cases it remains the driver's responsibility to drive safely according to the prevailing conditions.**
2. **It is recommended that when using snow chains, DSC should be switched OFF.**

General driving information



WARNING:

Ensure the handbrake is on and the gear selector is in position 'P' or 'N' before attempting to start the engine.

Before driving off, check the gauges and warning lights and messages. Take special note of any warning light that is on.

Seat belts are provided for your safety and it is unwise, and in certain countries illegal, to commence any journey, however short, without wearing them.

Warming up

Do not operate the engine at high speed when first started but allow time for the engine to warm up and the oil to circulate.

Engine braking on downhill gradients

When driving on mountain roads with long downhill gradients it is advisable to select a low gear.

Running-in

Apart from a few precautionary recommendations, there are no strict 'running-in' procedures for this vehicle.

By observing the following advisory notes you will ensure maximum engine, transmission and brake life for your vehicle:

1. Allow the engine to warm up thoroughly before operating at engine speeds over 3500rev/min.
2. Vary the speed frequently.
3. From 940 miles (1500kilometres) onwards, gradually increase performance of the vehicle up to the permitted maximum speed.

Running-in for brakes

To ensure that the brake pads can 'bed-in' evenly and reach their optimum wear and performance condition, usually within 300 miles (480kilometres), the following points are recommended.

1. Where possible, avoid heavy braking or rough usage of the brakes as this can result in damage being caused to the brake pads and discs.
2. Avoid prolonged use of the brakes, for example, when descending severe gradients.
3. Frequent light application of the brakes is desirable. This helps to fully 'bed-in' the brake pads before the normal running-in period is completed and the vehicle is operated at high speeds, when maximum brake efficiency will be required.

The above equally applies when new discs or pads have been fitted.

Use of headlamps in daylight

When visibility is poor the headlamps with dipped beam setting should be switched on so that the vehicle may be seen more easily by other road users. The instrument illumination dimmer control adjusts the brightness of the panel lighting.

Engine oil consumption

A certain amount of oil consumption is normal. The rate of consumption will depend on the following:

- The quality and viscosity of the oil.
- The amount of oxidation and dilution of the oil.
- Climatic conditions.
- The speed at which the engine is being operated.
- Road conditions.

Drivers should expect above normal consumption when the engine is new, and after running-in if high speeds are sustained.

Winter driving

Freeing a frozen door lock

Caution: Do not apply a proprietary lock de-icer through the keyhole.

Should the lock become frozen, warm the end of the key before use.

Windscreen wiper blades

Before driving away, clear any ice from the windscreen and check that the wiper blades are free. Switching on the heated screen will accelerate this process.

Frost precautions

The correct concentration of coolant must be maintained at all times when 'replenishing' or 'refilling' the cooling system.

Touring

Foreign travel

Before planning foreign travel, check with a motoring organisation to ensure that your vehicle will comply with legal requirements of the countries you intend to visit.

It is advisable to carry vital spare parts to ensure against a breakdown in a remote area.

International motoring organisations are helpful for all aspects of long distance touring advice.

In some countries it is a legal requirement to carry spare vehicle bulbs.

First aid kit

A first aid kit is compulsory equipment in certain countries. Your Jaguar Dealer can supply a first aid kit.

Fire extinguishers

Many countries make it compulsory to carry a fire extinguisher. Your Jaguar Dealer can supply and fit one.

Petroleum spirit in containers

Some countries forbid the carrying of petrol in containers, as do most ferry and hovercraft operators.

Cellular radio telephones

Ask your motoring organisation about the use of cellular radio telephones before travelling abroad, as some countries exercise controls on the importation and use of such equipment.

Roof-rack

Only the Jaguar approved roof-rack should be used.

The maximum load, including the weight of the rack, must not exceed the load rating indicated on the roof rack bars and **must** be deducted from the vehicle maximum luggage load.

Loads on the roof-rack may affect vehicle handling, especially in crosswinds or when cornering.

Jaguar warning triangle

A warning triangle to give traffic advanced notice of a disabled vehicle is compulsory in many countries. A triangle, designed to international standards is standard equipment in certain countries.

Hazard warning lights must be used with the warning triangle.

The warning triangle with its stand legs folded flat, is mounted on the inside of the luggage compartment lid.

In an emergency, remove the triangle and unfold its stand legs. Place the triangle in the road in accordance with local traffic regulations to give oncoming traffic warning of an immobilised vehicle.

4-44 On the road

Towing a caravan or trailer

Your Jaguar Dealer, and the main motoring and caravanning organisations can advise you on towing, towing weight capacities and about regulations that apply in other countries.

The following are important points of safety, stability and comfort upon which further advice should be sought:

- Maximum braked towing weight is permissible, provided long periods of uphill driving on gradients over 8% are not undertaken.
- In high altitude mountainous regions, the thinner atmosphere can reduce engine performance. Above 3280 feet (1000metres) the stipulated maximum permitted gross train weight must be reduced by 10% for every 3280 feet (1000metres) in altitude.
- The kerbside weight of the vehicle can be found in Section 8.
- When towing, the nose weight of the caravan or trailer and the tow-bar assembly must be deducted from the permissible maximum load (see Section 8).

- When towing at the maximum permissible rear axle load keep within legal towing speeds but in any case do not exceed 62 mph (100 km/h). Increase tyre pressures to 39 lbf/in² (2,5 bar).
- The recommended maximum tow-ball nose weight is 132 lb (60 kg). Having a lower nose weight or exceeding the maximum nose weight limit may impair the vehicle's handling.
- It is essential that only a Jaguar tow-bar and Jaguar electrical tow-bar kit are supplied and fitted by a Jaguar dealer.

Caution:

1. **Using electrical kits not specifically designed for this Jaguar will damage the electrical system of the vehicle.**
2. **When not in use, it is recommended that the removable tow-ball is either securely stowed in the luggage compartment or, preferably, not in the vehicle. Do not leave it loose in the vehicle.**

- Avoid heavy braking. As the overrun brake on the caravan or trailer is not connected to the ABS, heavy caravan or trailer braking could critically affect the stability of the outfit as a whole.
- Ensure that the towing vehicle's engine, transmission, suspension, brakes and tyres are fully efficient and regularly serviced. Similarly check the wheels, tyres, brakes and wheel bearings of the caravan or trailer.
- Adjust the headlight level to avoid dazzling other road users.

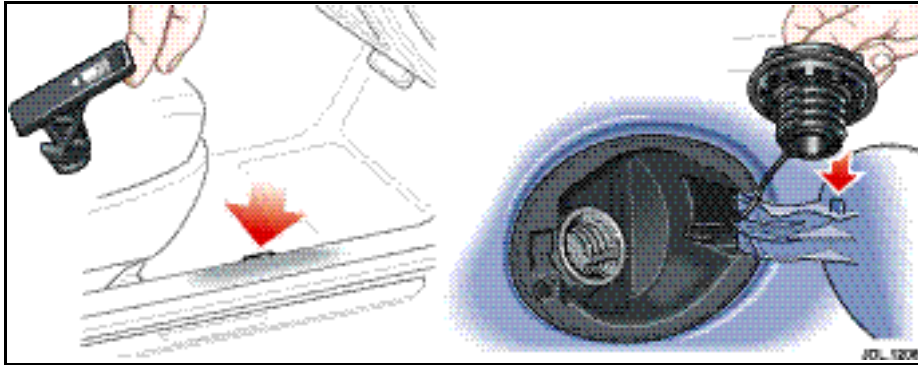

Caution: Vehicles with engines fitted with catalytic converters must only be filled with 'Unleaded Fuel'.



WARNING:

1. Fuel vapour is highly flammable and in confined spaces is explosive and toxic. In the event of inadvertent spillage, and before refuelling, always switch OFF the engine. Do not use exposed flame or light. Do not smoke. Do not inhale fumes.
2. Do not fill the tank so that fuel is visible in the fuel filler intake tube. This could cause spillage and danger from exposed fuel.

When filling, the dispenser nozzle must be inserted into the filler neck sufficiently to open the trap door for fuel to flow into the fuel tank. Fill the tank until the filler nozzle automatically shuts off. Filling beyond this point could result in fuel spillage.

After refuelling, twist the filler cap clockwise until it clicks and close the flap, which automatically locks shut.

Fuel and refuelling

Before refuelling, switch off the ignition and remove the key.

Note: Do not leave the ignition key in the vehicle; vehicles have been stolen from garage service/filling stations whilst the driver is absent from the vehicle. It is recommended that the vehicle is locked, if left unattended.

Fuel tank filling

The fuel filler flap release is located on the floor, outboard of the driver's seat. The filler flap is on the right-hand side of the vehicle.

Pull the lever to release the flap.

Turn the filler cap anti-clockwise, approximately 2½ turns, to unscrew the cap from the filler neck. The cap is held by a retaining strap which can be passed over the hook on the flap to allow easy access to fill the tank.

A warning label on the inside of the fuel filler flap advises type/grade of fuel.

4-46 On the road

The continuous use of high quality fuel makes the need for additional additives unnecessary. This will help to protect the engine components against corrosion, carbon deposit formation and prevent the fuel injection system from clogging.

If in doubt your local Jaguar Dealer will advise on which fuel must be used in your vehicle.

Emission control components

Owing to the legislative requirements or options available in some markets, a Jaguar Dealer should be consulted where any doubt exists as to the precise emission control system specification of this vehicle.

Fuel requirements

Any vehicle NOT fitted with a catalytic system can use either leaded or unleaded fuel.

The use of either leaded or unleaded fuel depends on the type of emission control system fitted to the engine and the legislative requirements in the country for which the vehicle is manufactured.

The preferred fuel is 95RON unleaded, where selection is available.

Unleaded fuel

The filler neck of the fuel tank is a small diameter to suit the unleaded fuel pump nozzle and will prevent the larger diameter leaded fuel nozzle from entering the filler neck.

Unleaded fuel must be used for the emission control system to operate properly. Its use will also reduce spark plug fouling, exhaust system corrosion and engine oil deterioration.

Use unleaded fuel with an octane rating of at least 95RON (Research Octane Number).

Note:

1. Some countries have only 91 RON fuel available. The vehicles in these countries are specially calibrated to use this fuel.
2. 'Super Green' Plus 98RON unleaded fuel (where available) may be used as an alternative to the standard 95RON unleaded fuel.

Using unleaded fuel with an octane rating lower than recommended can cause persistent, heavy 'spark knock' (a metallic rapping noise). If severe, this can lead to engine damage.

If a heavy 'spark knock' is detected even when using fuel of the recommended octane rating, or if you hear steady 'spark knock' while holding a steady speed on level roads consult a Jaguar Dealer to have the problem corrected. Failure to do so is misuse of the vehicle, for which Jaguar Cars Limited, is not responsible. However, occasional light 'spark knock' for a short time while accelerating or driving up hill, may occur.

Fuels containing alcohol

Caution: Take care not to spill fuel during refuelling. Fuel containing alcohol can cause paint damage, which may not be covered under the warranty.

Some fuel suppliers sell fuel containing alcohol without advertising its presence. Where uncertainty exists check with the service station operator.

Note: Some difficulty in starting may be encountered when using alcohol blended fuel.

Ethanol

Fuels containing up to 10percent ethanol (grain alcohol) may be used. Ensure the fuel has octane ratings no lower than those recommended for unleaded fuel. Most drivers will not notice any operating difference with fuel containing ethanol. If a difference is detected, the use of conventional unleaded fuel should be resumed.

Methanol

Some fuels contain methanol (methyl or wood alcohol). If you use fuels containing methanol the fuels must also contain co-solvents and corrosion inhibitors for methanol. Also, do not use fuels that contain more than three per cent methanol even if they contain co-solvents and corrosion inhibitors. Fuel system damage or vehicle performance problems resulting from the use of such fuels is not the responsibility of Jaguar Cars Limited, and may not be covered under the warranty.

Methyl Tertiary Butyl Ether(MTBE)

Unleaded fuel containing an oxygenate known as MTBE can be used provided the ratio of MTBE to conventional fuel does not exceed 15percent.

MTBE is an ether based compound, derived from petroleum, which has been specified by several refiners as the substance to enhance the octane rating of fuel.

Catalytic converters

A few precautions on the use of vehicles fitted with catalytic converters are necessary. These are:

1. In order to maintain the efficiency of the emission control system it is essential that unleaded fuel is used. Use of leaded fuel will seriously damage the catalytic converters.
2. Heavy impact on the converter casings must be avoided.
3. The engine settings must not be altered; they have been established to ensure that the vehicle will comply with stringent exhaust emission regulations. Incorrect engine settings could cause unusually high catalytic converter temperatures and thus result in damage to the converter and vehicle. If adjustment to the settings is considered necessary, this should be performed by a Jaguar Dealer.

4-48 On the road

Catalytic converters (continued)

4. A correctly tuned engine optimises exhaust emissions, performance and fuel economy and it is recommended that the vehicle is regularly maintained.
5. Do not continue to operate the vehicle if any engine malfunction is evident; malfunctions should be rectified immediately. For instance, misfire, loss of engine performance, excessive oil consumption or engine run-on may lead to unusually high catalytic converter temperatures and may result in damage to the converters and vehicle.
6. The use of catalytic converters increases exhaust system temperatures, therefore, do not operate or park the vehicle in areas where combustible materials such as dry grass or leaves may come into contact with the exhaust system.
7. Do not run the engine with either a spark plug lead disconnected or a spark plug removed. Do not use any device that requires an insert into a spark plug hole in order to generate air pressure e.g. tyre pump, paint spray attachment etc., as this could also result in catalytic converter damage.
8. The vehicle is designed for normal road use. Below are examples of abuse which could damage the catalytic converters and vehicle. These may lead to a dangerous condition due to excessively high catalytic converter temperatures.
 - Competition or off-road use.
 - Excessive engine speed.
 - Overloading the vehicle.
 - Switching off the engine whilst in gear.

Introduction

This vehicle is fitted with one of the following climate control systems:

- Manually controlled system with air conditioning. See page5-4.
- Automatic climate control system with an LCD (liquid crystal display) screen. See page5-7.
- Automatic climate control system with touch screen (shared with the navigation and audio systems). See page5-11.

Each system has a unique control panel located in the centre console above the radio and audio controls.

Operating instructions for each system are on the following pages, with general information, applicable to all three systems, given below.

The climate control systems may also be operated by spoken commands if the optional voice activation system is fitted. For full information on the use of this system refer to the Voice Activation Handbook.

Recommended operation

Use of air conditioning

The manual and automatic climate control systems are fitted with air conditioning to provide cooling and dehumidified air.

The dry airflow is also effective in preventing misting of the windows. It is recommended that air conditioning is used in all climatic conditions throughout the year.

Close all windows and the sunroof when the air conditioning is on to ensure satisfactory operation.

Use of air recirculation

The air conditioner/heater system is supplied with fresh air via an intake flap.

The flap may be closed to allow the air inside the vehicle to be recirculated. This helps to prevent unpleasant odours from being drawn into the vehicle.

On all systems, air recirculation may be manually selected either for an automatically timed period or to remain on continuously (latched recirculation).

When latched recirculation is selected, the air conditioning will switch on automatically to reduce condensation.

Automatic climate control systems

With automatic climate control systems, the air conditioning, recirculation and other functions are fully controlled in AUTO mode to provide optimum comfort under most driving conditions.

It is recommended that AUTO is selected as the normal operating mode on these systems.



WARNING:

To prevent humidity build up inside the vehicle and possible screen misting, avoid driving with the air conditioning system off or in manual air recirculation for prolonged periods.

5-2 Climate control

General points

To ensure the satisfactory operation of the climate control system, note the following points:

- Ensure that the external grille at the base of the windscreen, which provides fresh air for the climate control system, is kept clear of leaves, snow or obstructions.
- Vehicles with automatic climate control systems have a solar sensor mounted on top of the fascia on the driver's side, as shown overleaf (A). Ensure that this sensor is not covered.
- Air ducts under the front seats supply the rear passenger footwells (see illustration overleaf). Objects or material placed under the seats may block or obstruct the open ducts.
- The external air intake to the air conditioner/heater system is fitted with a filter. Ensure that the filter is changed at the specified service intervals to maintain efficient operation.

- If the air conditioning system is not used frequently, it should be run briefly at least once each week, with a cold setting, to prevent the seals from drying out with subsequent refrigerant leaks.
- Moisture removed from the air by the air conditioning unit is discharged onto the road underneath the vehicle. After stopping, puddles of water may form underneath the vehicle.

Panel illumination

With the exterior lighting switched on, the graphics on the panel controls are illuminated by low level backlighting.

The illumination level is adjusted by the common instrument panel dimmer control.

Air distribution

The illustration overleaf shows the location of the air vents within the vehicle.

On all climate control systems, the distribution of air between the screen, fascia and floor level can be manually selected using the panel controls.

On vehicles fitted with automatic climate control, the appropriate air distribution is selected automatically when operating in AUTOmode.

The airflow from the fascia face level vents is regulated using thumbwheel controls and adjustable direction vanes.

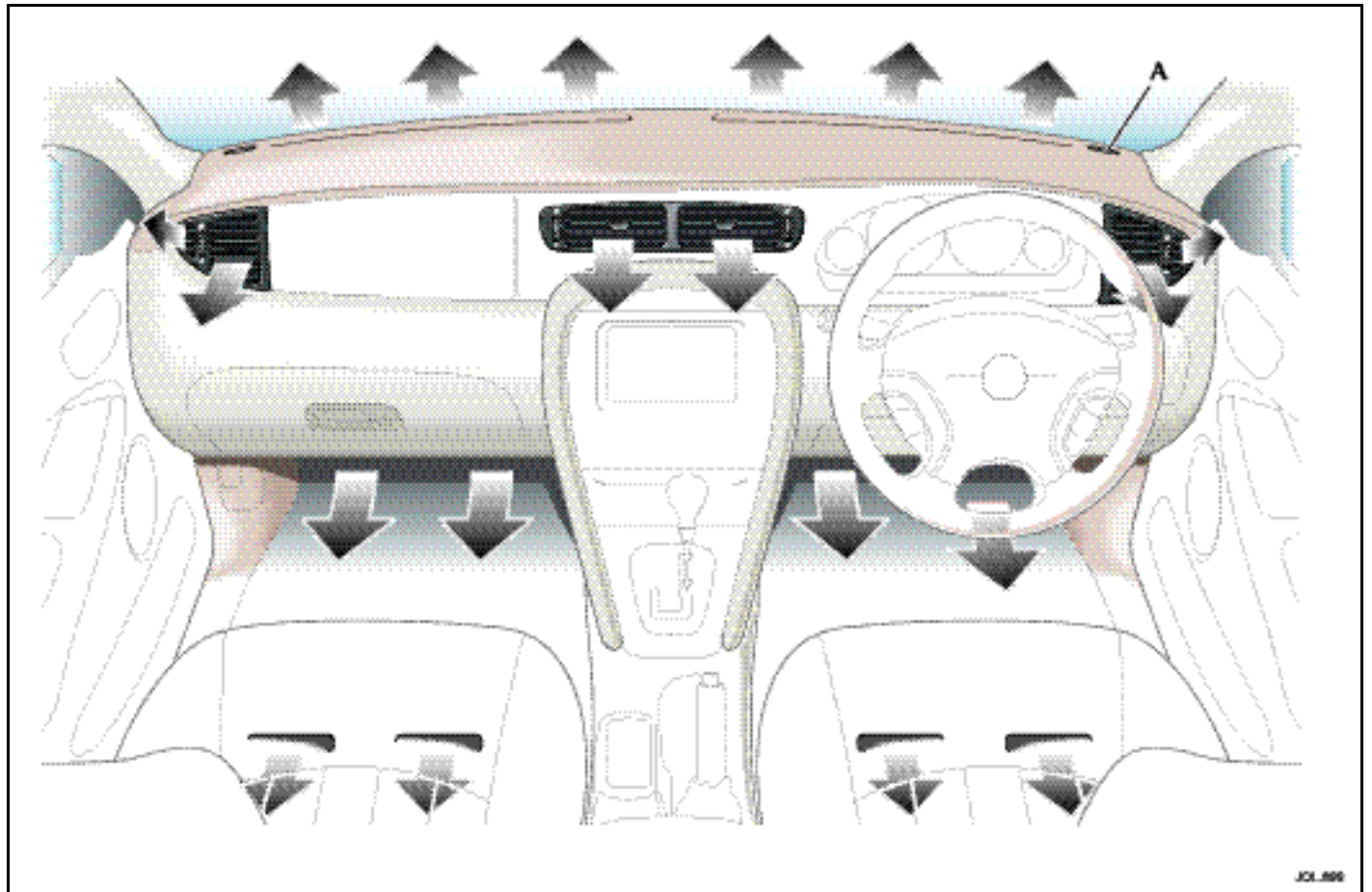

5-4 Climate control

Manual climate control

The manual climate control panel is shown here. The temperature, airflow distribution and volume of air from the interior vents are set using the rotary controls.

Push on/push off buttons control the air conditioning, screen heating and fresh or recirculated air. An amber or red LED on each button is illuminated when the selected function is operating.

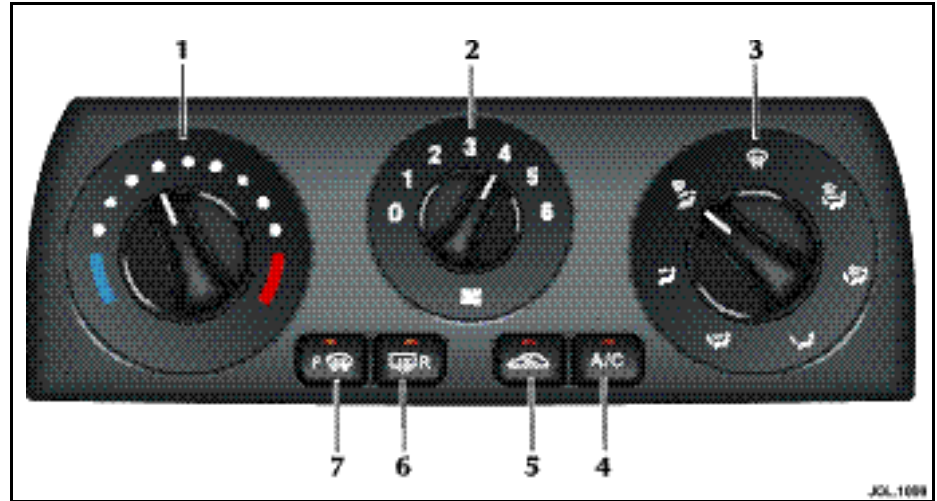

Manual control panel

1. Temperature control
2. Fan speed
3. Air distribution
4. Air conditioning
5. Recirculated/fresh air
6. Heated rear screen
7. Heated front screen (where fitted)

Temperature

Rotating the control knob(1) clockwise from the blue region to the red region increases the temperature of the airflow. The knob may be set to any position for optimum comfort.

Fan speed

The fan is off in position0 of the rotary control(2) and switching through positions1–6 provides stepped increases in fan speed.

With the fan switched off in position0, the airflow results from the forward motion of the vehicle (ram air effect).

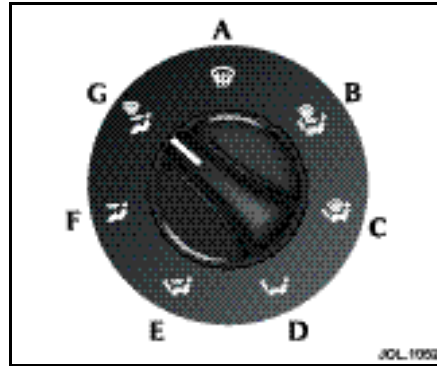

Air distribution

The rotary control has seven main air distribution positions but the air distribution changes continuously between positions as the knob is rotated. The control knob may therefore be set at any point for optimum comfort.



WARNING:

Directing cold air onto the screen in warm humid conditions can produce external condensation.

The air distribution settings are, from the top clockwise:



Air flow directed to windscreen only(A); select to remove frost or heavy misting.



Air flow distributed to the windscreen, face and foot levels (B).



Air flow distributed to the windscreen and feet (C); select to prevent or remove light misting and when heating the interior.



Air flow directed to foot level(D); select to heat interior.



Air flow distributed to the face and feet(E).



Air flow directed at face level only(F); select to cool interior.



Air flow distributed to the windscreen and face(G).

5-6 Climate control

Air recirculation



Press the button briefly to select timed air recirculation.

To select latched air recirculation, press and hold the button until the LED flashes four times then remains illuminated.

To deselect air recirculation and open the fresh air intake, press the button again (LED off).

Note that air recirculation cannot be selected in position A (defrost) of the air distribution control.

Select air recirculation:

- to stop outside odours from entering the vehicle.
- to improve the performance of the air conditioning in regions of high ambient temperatures or when the interior is extremely hot. Note that air recirculation is cancelled when the ignition is switched off, and must therefore be re-selected after each engine start if required.



WARNING:

Prolonged operation with recirculation selected in cold, damp conditions could result in interior condensation.

Air conditioning



The air conditioning only operates with the fan switched on and will switch off if fan position 0 is selected.

If the air distribution control is set to any of the screen defrost/demist positions (A, B, C, G), the air conditioner switches on automatically.

Air conditioning cannot be deselected in defrost position A.

Heated front and rear screens



Pressing the push button selects the front screen heater (if fitted), provided the engine is running.

The front heater switches off automatically after 4 minutes or can be switched off by pressing the button again.



Pressing the button selects the rear screen heater and both door mirror heaters, provided the engine is running.

The rear screen and door mirror heaters switch off automatically after 10 minutes or can be switched off by pressing the button again.

Windscreen defrost/demist

Frost and heavy misting

To remove frost or heavy misting from the windscreen:

1. Start the engine.



2. Turn the air distribution mode control to the defrost/demist position (A).

3. Set the temperature control to maximum to remove frost.

4. Select a fan speed, preferably maximum (position 6). The air conditioning will switch on automatically.

5. If fitted, select the front windscreen heater.

6. If required, select the rear screen heater; this control also switches on both door mirror heaters.

Light misting



To prevent or remove light windscreen misting, select air distribution position C.

Automatic climate control with LCD screen

The automatic climate control system maintains the interior of the vehicle at the temperature selected by the occupant. The heat input, air conditioning, fan speed, air intake and distribution are adjusted automatically to maintain the desired temperature.

Automatic control(AUTO) may be overridden at any time. Defrost/demist operation is available and also manual selection of fan speed, air distribution, recirculation, air conditioning and windscreen heating.

The climate control functions are selected by push buttons and a rotary control. When a button is pressed, selection is confirmed by a beep and illumination of the buttonLED.

Most functions also have associated graphic symbols displayed on the LCD (liquid crystal display) screen.

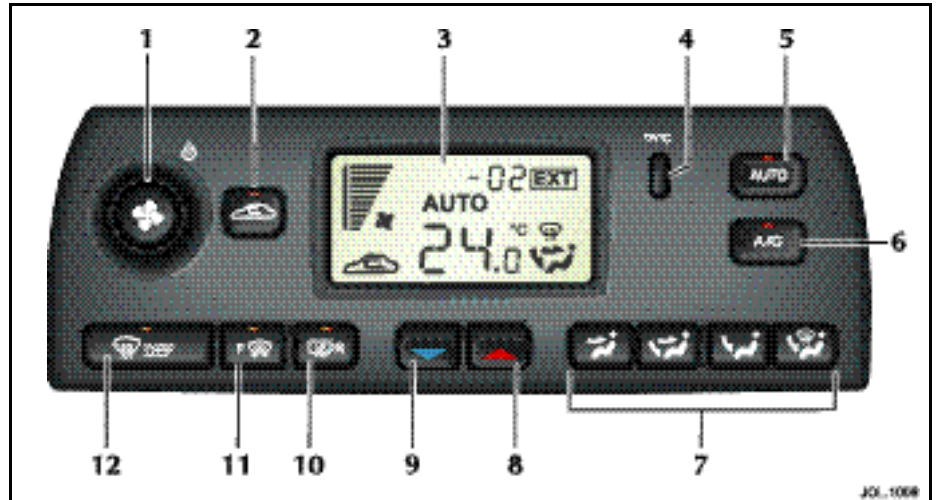

Control Panel

- | | |
|---------------------------------------|-------------------------------------|
| 1. Fan speed and system on/off | 7. Air distribution |
| 2. Recirculation/fresh air | 8. Increase temperature |
| 3. Display panel with typical symbols | 9. Decrease temperature |
| 4. Celsius/Fahrenheit selector | 10. Heated rear screen/door mirrors |
| 5. Automatic operation | 11. Heated front screen |
| 6. Air conditioner on/off | 12. Defrost |

5-8 Climate control

To switch the system on

The climate control system operates in position II (run) of the ignition switch. With the ignition key turned to the run position, the system will switch on in the operating mode last set.

For normal usage select AUTO mode.

AUTO mode

Automatic operation provides a controlled environment over a temperature range of 17°C(61°F) to 31°C(89°F) and should be regarded as the normal operating mode.



To select automatic climate control press the AUTO button; the word AUTO appears on the LCD screen to confirm selection.

Select the required temperature.

Front and rear screen heating and timed air recirculation may be selected in AUTO mode. Selecting any other control will cancel AUTO operation.

Automatic operation cannot be deselected using the AUTO button. To exit AUTO mode, select another mode or press the fan control knob to switch the system off.

Temperature selection



Set the required interior temperature with the red and blue arrowed buttons. Press the red button to increase temperature and the blue button to decrease temperature.

The selected temperature will appear on the lower part of the LCD screen.

Pressing the buttons to select the maximum or minimum temperature settings causes the display to change to HI or LO respectively and cancel AUTO mode.

To quickly jump from HI or LO to a convenient midrange temperature of 23°C(73°F), press and hold AUTO for a few seconds.

External temperature

The external(EXT) temperature is displayed at the top of the screen.

Celsius/Fahrenheit selection



Press the button to change the scale between degrees Celsius (°C) and degrees Fahrenheit (°F) for the displayed internal and external(EXT) temperatures.

Air recirculation

Timed air recirculation



Press the button briefly to select timed air recirculation.

The fresh air intake is opened and the button LED extinguished at the end of the time out period.

Latched air recirculation



Press and hold the button for a few seconds to select latched air recirculation. Selection is indicated by the displayed vehicle symbol and two beeps.

Selecting latched air recirculation cancels AUTO operation.

To deselect latched air recirculation, press the recirculation button again, or select AUTO.



WARNING:
Prolonged operation with recirculation selected in cold, damp conditions could result in interior condensation.

Windscreen defrost/demist

Frost and heavy misting



To remove frost or heavy misting from the windscreen, press the

DEF button.

- The fan switches on automatically at maximum speed but the speed can be reduced manually if required.
- Air conditioning switches on automatically and cannot be deselected.
- Recirculation is cancelled and cannot be selected.
- The front screen heater and the rear screen heater/door mirror heaters switch on automatically, provided the engine is running.

To deselect defrost mode, press AUTO (recommended operating mode).

Light misting



To prevent or remove light windscreen misting, select manual air distribution to windscreen and feet. See page 5-10.

Heated screens and door mirrors



The front (F) and rear (R) screen heaters may be switched on and off in any mode, including system off, but only operate when the engine is running. The door mirror heaters are also controlled by the rear screen heater button.

The front screen heater switches off automatically after 4 minutes. The rear screen and door mirror heaters switch off automatically after 10 minutes.

The windscreen heaters may be manually deselected during the time out period using the push buttons.

In cold ambient conditions, at the start of a journey, the front and rear screen heaters will switch on automatically for the time out period.

Air conditioning



Press to switch the air conditioning on or off.

The air conditioning system is controlled automatically in AUTO mode. Deselecting A/C cancels AUTO mode.

The air conditioning system is also switched on automatically in defrost mode (DEF) but cannot be deselected.

Fan speed



Set the fan speed as required with the rotary control knob.

Fan speed is shown as a series of bars on the LCD screen.

When operating in AUTO mode, fan speed is controlled automatically (but not displayed) and any adjustment of the knob will cancel AUTO mode.

Note: In AUTO mode, the fan only operates at low speed, if heating is required, until the engine is warm.

5-10 Climate control

Manual air distribution

Air distribution is automatically controlled in AUTO and defrost modes.

Press one of the four air distribution buttons to cancel the current mode and select manual operation. The symbol for the selected air distribution will appear on the LCDscreen.

The air distribution options are:



Air flow directed at face level only; select to cool the interior.



Air flow distributed to the face and feet.



Air flow directed to foot level; select to heat the interior.



Air flow distributed to the windscreen and feet; select to prevent or remove light misting and when heating the interior.

To switch the system off



Press in the fan rotary control knob to switch the climate control system off.

If the fan control knob is pressed again, the system will switch on in the previous mode set.

Ram air

With the climate control system switched off, air recirculation is automatically selected (intake flap closed). To select fresh air with the system off, press one of the air distribution buttons.

With the fan switched off, the fresh airflow results from the forward motion of the vehicle (ram air effect).

Automatic climate control with touch screen

Operating modes

The automatic climate control system maintains the interior of the vehicle at the temperature selected by the occupant. The heat input, air conditioning, fan speed, air intake and distribution flaps are adjusted automatically to maintain the desired temperature.

Automatic control(AUTO) may be overridden at any time. Defrost/demist operation is available and also manual selection of fan speed, air distribution, recirculation, air conditioning and windscreen heating.

Controls and displays

Multi-function console

The system is controlled from the multi-function centre console which also provides user control of other facilities (such as audio, telephone, navigation system).

Climate controls

The climate control system has its own, manually selected, touch screen displays providing 'soft' control buttons. Touching the screen button with a finger has the same effect as pressing a push button. Refer to the general description and usage of the touch screen in Section 1 of this Handbook.

Note that using other systems and touch screens, such as audio or navigation, does not affect the climate control settings.

A number of push buttons are also used for climate control and are located around the touch screen. When a push button is pressed, selection is confirmed by a beep and illumination of an LED on the button (except temperature controls).

LCD screen

An LCDscreen below the touch screen shows clock time, external(EXT) ambient temperature and the required interior temperature set by the occupant.

5-12 Climate control

Controls

1. Select climate control touch screen
2. Fan speed
3. Air conditioner on/off
4. Automatic operation
5. LCD screen: interior/exterior temperatures and clock
6. Decrease set temperature
7. Increase set temperature
8. Heated rear screen/door mirrors
9. Heated front screen
10. Defrost operation
11. Select recirculated air
12. Touch screen



Ignition on

The climate control system operates in position II(run) of the ignition switch.

When the ignition is switched to run or the engine is started, the Jaguar logo will be displayed briefly followed by the last touch screen selected (e.g.radio).

The climate control system will be set to the climate operating mode selected previously.

Climate control touch screen displays

There are two climate control touch screens displays, one for the system on state and the other for system off/ram air mode. Smaller overlay displays appear briefly when selecting air recirculation or adjusting the fan speed.

Most climate functions can be selected using the peripheral push buttons without displaying the climate touch controls.



To select the touch screen display, press the CLIMATEbutton.

To exit the climate control screen, select another system function, e.g.AUDIO.



AUTO mode

Automatic operation provides a controlled environment over a temperature range of 17°C(61°F) to 31°C(89°F) and should be regarded as the normal operating mode.



To select automatic climate control press the AUTObutton.

Select the required temperature.

The AUTOmode touch screen is shown above. If the touch screen is not displayed, press the CLIMATEbutton.

Front and rear screen heating and timed air recirculation may be selected while remaining in AUTOmode. Selecting any other climate control push button or touch screen button will cancel AUTOoperation.

Automatic operation cannot be deselected using the AUTObutton. To exit AUTOmode, select another climate mode or touch the SYSTEMON/OFF screen button to switch the system off.

Temperature selection



Set the required interior temperature with the red and blue arrowed

buttons. Press the red button to increase temperature and the blue button to decrease temperature.

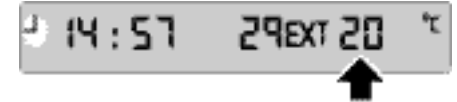

The selected temperature will appear on the LCDscreen.

Pressing the buttons to select the maximum or minimum temperature settings causes the LCDdisplay to change toHI orLO respectively and cancel AUTO mode.

To quickly jump fromHI orLO to a convenient midrange temperature of 23°C(73°F), press and holdAUTO for a few seconds.

5-14 Climate control

External temperature



The external(EXT) temperature is displayed on the LCDscreen.

Celsius/Fahrenheit selection



Touch the screen button to change the scale between degrees Celsius(°C) and degrees Fahrenheit(°F) for the displayed internal and external(EXT) temperatures.



Timed air recirculation



Press the button briefly to select air recirculation for a timed period only; the overlay screen shown above will appear for a few seconds on top of the currently selected touch screen.

The fresh air intake is opened and the buttonLED extinguished at the end of the time out period.



Latched air recirculation

To latch air recirculation (so that it remains selected), press and hold the air recirculation button until the overlay screen changes from the timed to the latched recirculation symbol.

Selection is also indicated by two beeps.

Selecting latched recirculation cancels AUTOMode.



WARNING:
Prolonged operation with recirculation selected in cold, damp conditions could result in interior condensation.

Latched fresh air

Pressing the air recirculation button when the button LED is illuminated will cancel recirculation and allow fresh air into the vehicle.

Deselecting air recirculation cancels AUTO mode.

Windscreen defrost/demist

Frost and heavy misting



To remove frost or heavy misting from the windscreen, press the DEF button.

- The fan switches on automatically at maximum speed but the speed can be reduced manually if required.
- Air conditioning switches on automatically and cannot be deselected.
- Recirculation is cancelled and cannot be selected.
- The front screen heater and the rear screen heater/door mirror heaters switch on automatically, provided the engine is running.

To deselect defrost mode, press AUTO (recommended operating mode).

Light misting



To prevent or remove light windscreen misting, select manual air distribution to windscreen and feet. See page 5-16.

Heated screens and door mirrors



The front screen heater (F) and the rear screen heater (R) may be switched on and off in any mode, including system off, but only operate when the engine is running. The door mirror heaters are also controlled by the rear screen heater switch.



The front screen heater switches off automatically after 4 minutes. The rear screen and door mirror heaters switch off automatically after 10 minutes.

The windscreen heaters may be manually deselected during the time out period using the push buttons.

In cold ambient conditions, at the start of a journey, the front and rear screen heaters will switch on automatically for the timed period.

5-16 Climate control

Air conditioning



Press the A/C button to switch the air conditioning on or off.

The air conditioning system is controlled automatically in AUTOMode. Deselecting A/C cancels AUTOMode.

The air conditioning system is also switched on automatically in defrost mode (DEF) but cannot be deselected.

Fan speed



Set the fan speed as required using the rocker button. Fan speed is shown as a series of bars on the touch screen.

If the fan speed is changed while a non climate control touch screen is displayed, an overlay display showing the fan speed bars will appear for a short period.

When operating in AUTOMode, fan speed is controlled automatically (but not displayed) and any adjustment of the control button will cancel AUTOMode.

Note: In AUTOMode, the fan only operates at low speed, if heating is required, until the engine is warm.

Fan MUTE



To reduce the interior noise level, the fan speed may be quickly reduced to a preset level by touching the MUTE screen button.

Selecting MUTE will cancel AUTOMode but touching the MUTE button again will return operation to the previous state.

If voice activation is fitted, the climate control system will automatically prevent any increase in fan speed while speech commands are given.

Manual air distribution

Air distribution is automatically controlled in AUTO and defrost modes.

Touch one of the four air distribution buttons on the screen to cancel the current mode and select manual operation.

The air distribution options are:



Air flow directed at face level only; select to cool the interior.



Air flow distributed to the face and feet.



Air flow directed to foot level; select to heat the interior.



Air flow distributed to the windscreen and feet; select to prevent or remove light misting and when heating the interior.



Switching climate control off



To switch the system off, touch the System On/Off button on the CLIMATE

CONTROL screen. The touch screen will change to the system off/ram climate control screen above.

Pressing the System On/Off button will return the system to the previous state.

It is recommended to select AUTO to switch the system on again.



Ram air

With the climate control system switched off, air recirculation is automatically selected (intake flap closed).

To select fresh air with the system off, touch the ram air screen button (bottom left on illustration). The intake flap will open with air distribution to face level automatically selected.

Any of the other air distribution modes may be selected manually using the touch screen.

With the fan switched off, the fresh airflow results from the forward motion of the vehicle (ram air effect).

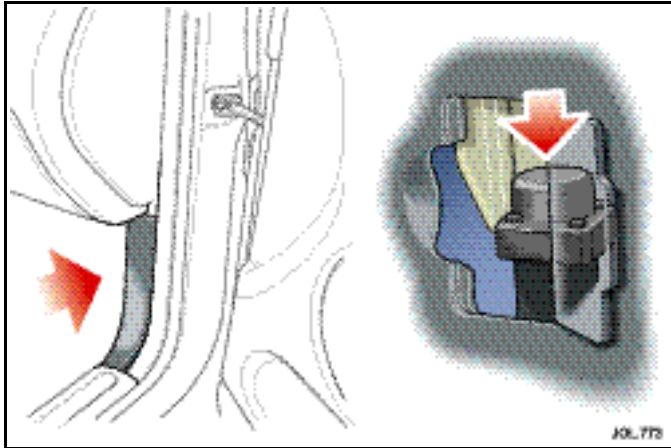

Inertia switch

In the event of an accident, an inertia switch will trip, isolating fuel pump operation. Once the switch has tripped it must be reset before attempting to restart the engine.

The inertia switch is located behind the trim on the right-hand side of the vehicle, forward of the front door post, below the fascia. Pull open the small panel in the trim to reset the switch.

Resetting the switch



WARNING:

To avoid the possibility of fire or personal injury, do not reset the inertia switch if you see or smell fuel.

If no fuel leak is apparent, reset the inertia switch as follows:

1. Turn the ignition switch to position '0'.
2. Pull open the small panel in the trim.
3. Press down the flexible cover on the top of the inertia switch.
4. Turn the ignition switch to position 'II', pause for a few seconds, then return the key to position '0'.
5. Make a further check for fuel leaks.
6. Close the trim panel.

6-2 Roadside emergency

Emergency starting



WARNING:

1. It will not be possible to push or tow start a vehicle with automatic transmission.
2. Only jump lead starting or the fitting of a fully charged battery is recommended.

Rolling start (manualtransmission only)



WARNING:

Because of the dangers to other road users, extreme caution must be exercised when attempting a rolling start.

A rolling start is pushing or towing the vehicle at low speed, in gear (preferably 2nd) with the clutch pedal depressed and the ignition switch in position 'II'.

When sufficient forward speed is obtained, the clutch pedal is gently released and the traction force from the wheels starts the engine.

Emergency starting using jump leads

Both the booster and discharged battery should be treated with great care when using jump leads. Always use high quality leads capable of carrying the starter current of the vehicle to be started.

Before commencing, the following precautions must be taken:

- When the battery of another vehicle is being used, ensure that the vehicles do not touch. Alternatively, remove the charged battery and place near to, not on, the vehicle with the discharged battery.
- Ensure that both vehicles have all electrical services OFF, the handbrake is ON and, with automatic transmission, 'P' is selected.
- Where the jump leads are of a different colour, e.g. red and black, use red for positive (+). This aids identification and helps to avoid crossing positive(+) to negative(-). Take extra care to avoid crossing the polarity when using cables of the same colour.

Caution:

1. If using a jump start vehicle, under no circumstances should the vehicles come into contact with each other. This could establish an earth connection, which may cause sparks and damage.
2. Do not run the jump start vehicle's engine when boost starting a Jaguar Vehicle. If the jump start vehicle's engine is running and the jump leads are disconnected, damage to the Jaguar vehicle's electrical system will result.
3. The booster battery voltage must not exceed 12volts.

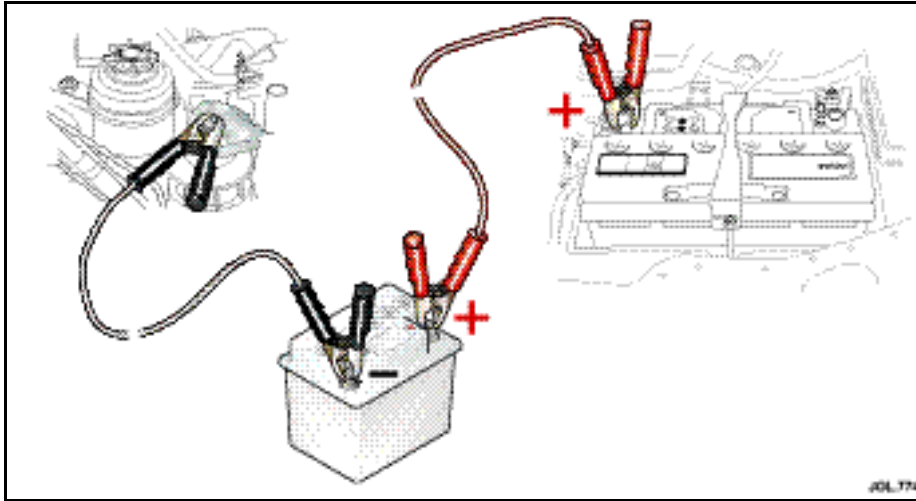

6. When started, allow the engine to idle for five minutes before disconnecting the cables.
7. Disconnect the black jump lead from the engine mount point and the booster battery negative (-) terminal.
8. Disconnect the red jump lead from the positive (+) terminals of both batteries.
9. Refit the battery box cover.

Emergency starting using jump leads (continued)

The following procedure must be followed exactly, being careful not to cause sparks:

1. Apply the handbrake, select 'P' (automatic transmission vehicles only), and turn off all the vehicle's electrical services.
2. Open the bonnet to gain access to the battery.
3. Unclip the battery cover.
4. Attach one end of the red jump lead to the positive (+) terminal of the booster battery and the other end to the positive (+) terminal of the discharged battery. Make sure that a good connection is made.
5. Attach one end of the black jump lead to the negative (-) terminal of the booster battery and the other end to the engine mount, as shown. Make sure that a good connection is made.

Caution: Do not connect the negative jump lead directly to the negative (-) terminal of the discharged vehicle.

6-4 Roadside emergency

Wheel changing and jacking

Be prepared for a flat tyre. Know where equipment is stowed and read the wheel changing and jacking instructions carefully. Pull off the road completely, clear of all traffic and park on as level, solid ground as possible. Switch on hazard warning lights and, where legally required, display the warning triangle.



WARNING:

It can be dangerous to change a wheel when the vehicle is on a slope or soft, uneven ground.

The spare wheel and jacking equipment are stored under the luggage compartment floor panel.

To remove the spare wheel, lift the luggage compartment floor panel. If a temporary-use spare wheel is stowed then the tray will need to be removed to gain access to the wheel. Unscrew the retaining nut (A) and remove the spare wheel. Remove the jack and wheel nut wrench (and locking wheel nut kit, if fitted).

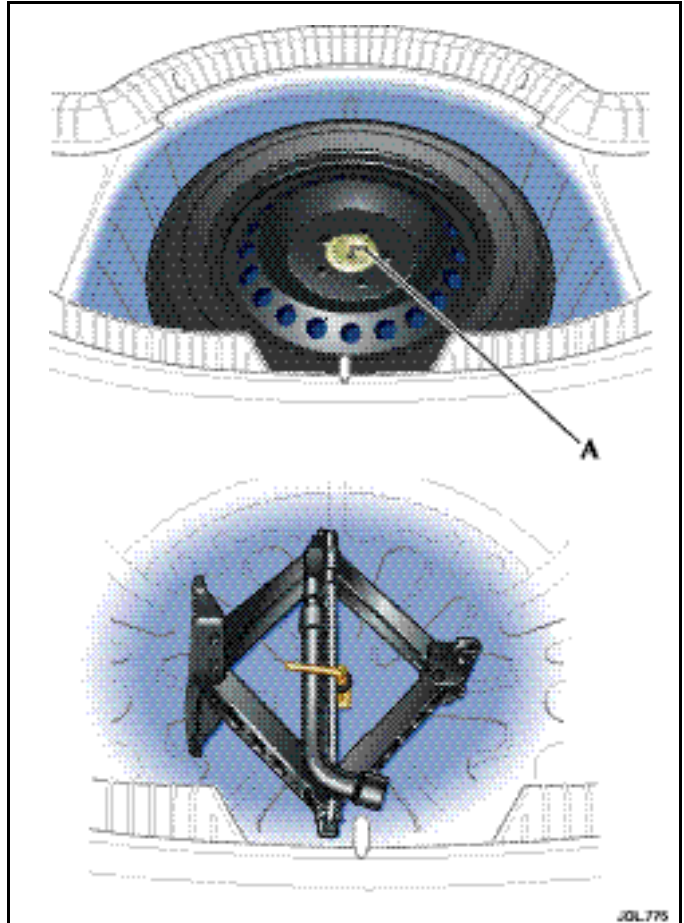

Temporary-use spare wheel

Observe the following warnings before using the wheel.



WARNING:

1. Please note temporary-use spare wheel warning label. Adhere to instructions on the label. Failure to comply can be dangerous.
2. When a temporary-use spare wheel is fitted, drive with caution and replace with the specified wheel and tyre as soon as possible.
3. Do not fit more than one temporary-use spare wheel and tyre assembly at one time.
4. The temporary-use spare wheel must be inflated to the correct pressure. See Chapter 8.
5. Temporary-use spare wheel, maximum speed is 50 mph (80km/h).

Note: Maintenance information for the temporary-use spare wheel is the same as given for normal tyres.

Locking wheel nuts

Some vehicles are fitted with one locking wheel nut on each wheel. These can only be removed using the extractor tube and key socket located in the luggage compartment.

The locking wheel nut has a cover which makes it visually similar to standard wheel nuts. The top of the cover has an indentation (A) to aid identification.

Push the extractor tube firmly over the locking wheel nut cover, as shown at (B), until it is fully located.

Withdraw the extractor tube to remove the cover.

Fit the key socket over the locking wheel nut as shown at (C).

Fit the wheel nut wrench over the key socket and loosen the locking wheel nut.

Locking wheel nuts have a letter stamped on their upper surface. The key socket is stamped with a corresponding number. Only key sockets with the correct matching number will fit the locking wheel nut.

Should a new key socket be required, note the letter on the locking wheel nut and contact your Jaguar Dealer. Proof of vehicle ownership will be required.

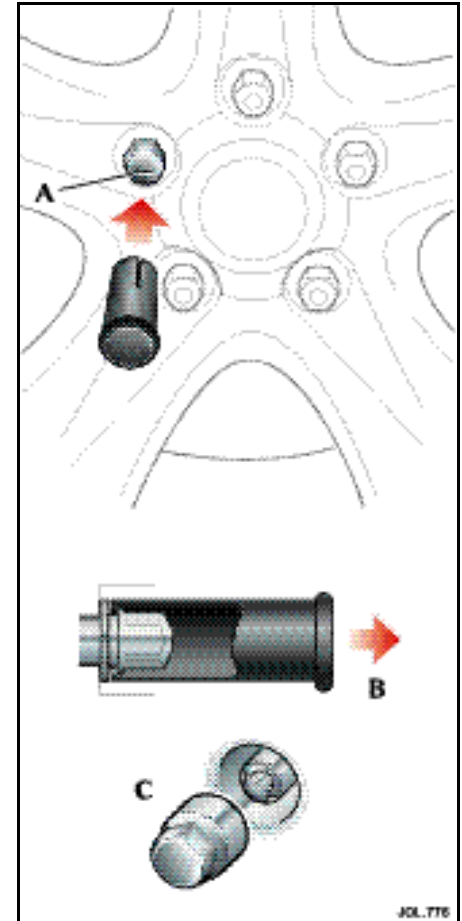

6-6 Roadside emergency

Wheel changing

Caution:

1. Ensure that all passengers are in a safe place, clear of the vehicle.
2. Firmly apply the handbrake.
3. For automatic vehicles, select gear position 'P'(Park).
4. For vehicles with manual transmission, select a low gear.
5. Ensure that the jack is placed on firm and level ground.



WARNING:

Before attempting to lift the vehicle with the jack, block a wheel diagonally opposite to the wheel being replaced to prevent the vehicle from rolling when jacked up.

Before raising the vehicle, extend the telescopic wheel nut wrench and slacken, but do not remove the wheel nuts.



WARNING:

Never work under the vehicle using only the jack as a support, always use axle stands or suitable supports under the jacking points.

Observe the instructions printed on the jack.

Use the jack only for lifting the vehicle during wheel changing, and only use the jack which is stored in the vehicle.

Do not start or run the engine while the vehicle is only supported by a jack.

Note: When one rear wheel is lifted off the ground the selection of a low gear on manual vehicles or automatic transmission 'P'(Park) position will not prevent the vehicle from moving and possibly slipping off the jack.

Caution: Ensure that when anyone requires to raise the vehicle that the jack is correctly positioned to avoid any damage to the vehicle sills or sill panels. Use only the correct jacking points, never use bumpers or any other part of the body to lift the vehicle.

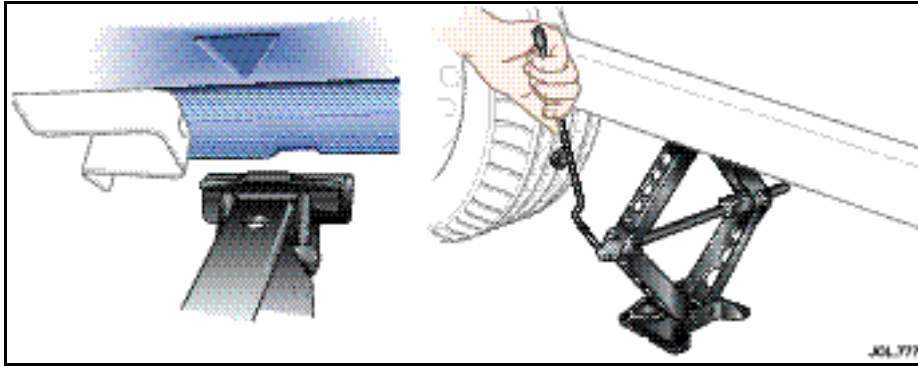

When changing the alloy road wheels, transfer the centre badge to the replacement wheel (when a full-size spare wheel is used). Using the rounded end of the wheel nut wrench handle from the inside of the wheel, push the centre badge from its housing. Push the centre badge into the replacement wheel. If the temporary-use spare wheel is to be fitted, keep the centre badge safe and fit it to the repaired full-size wheel when it has been refitted.

There are four jacking points, two each side of the vehicle on the underside of the floor. These provide positive location for the jack.

Two indented, triangular jack location points are provided on each sill cover.

The simplest way to correctly locate the jacking point is to feel along the sill panel to the triangular indentation and then fit the jack head to the body flange as shown in the illustration above.



WARNING:

- 1. Do not attempt to lift the vehicle unless the jack head is fully engaged in the jacking point.**
- 2. Ensure that the handbrake is fully applied.**

Place the jack squarely beneath the appropriate jacking point. Ensure that the jack head is fully engaged. Carefully raise the vehicle by turning the handle. Stop jacking the vehicle when the tyre just clears the ground. Minimum tyre lift gives maximum vehicle stability.

Remove the wheel nuts and the wheel.



WARNING:

When the temporary-use spare wheel has been fitted, drive with caution and replace with the specified wheel and tyre as soon as possible.

6-8 Roadside emergency

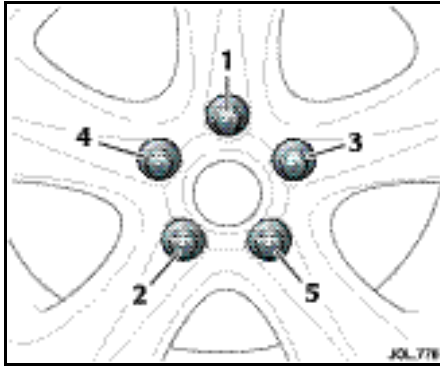

Fit the spare wheel and loosely secure with the wheel nuts.

Using the wheel nut wrench, lightly tighten the wheel nuts alternately using the sequence shown in the illustration.

Lower the jack and tighten the wheel nuts alternately, **DO NOT OVERTIGHTEN**.

At the earliest opportunity have the wheel nuts tightened with a torque wrench to:

Alloy wheels:

- 75.95 lb.ft. \pm 11.4 (103 Nm \pm 15.5).

Steel wheels:

- 59.0 lb.ft. \pm 8.5 (80 Nm \pm 12.0).

This torque must not be exceeded.

Stowing the equipment

Stow the jack and wrench.

Stow the replaced road wheel in the luggage compartment, position the wheel and secure with the retaining nut.

Reposition the luggage compartment floor panel.

Note: Examine the jack occasionally and clean and grease the threads to ensure it is always ready for an emergency.

Vehicle recovery

Caution: The preferred and recommended vehicle recovery method is by using a flat bed transporter.

The removable towing eye is primarily for emergency use when towing for SHORT DISTANCES, e.g. removing the vehicle if it is causing an obstruction or for winching the vehicle onto a recovery transporter.

Caution:

- **Do not tow the vehicle with the front wheels lifted unless the propshaft to the rear wheels is disconnected at the final drive flange. If the propshaft is not disconnected, the rotating rear wheels will force the front wheels to rotate, even with the gear selector in neutral.**
- **The vehicle can be towed with all four wheels on the ground, provided there is no damage to the transmission, for a maximum distance of 30miles (50kilometres) with the speed not exceeding 30mph (50km/h).**
- **Ensure that the recovery team do not tow with sling-type equipment since damage to the bodywork may result.**

Vehicle failure

To prevent damage to the automatic transmission whilst the vehicle is being towed with the rear wheels on the ground, towing distance must be restricted to 0.5miles (0.8kilometres). Towing speed must not exceed 30mph(50km/h).

Always obey towing regulations. In certain countries the registration number of the towing vehicle and an 'ON TOW' sign or warning triangle must be displayed in a prominent position at the rear of the vehicle being towed.

When being towed, the vehicle's gear selector lever must be in neutral (position 'N') with the ignition key turned to position 'II' to release the steering lock and render the indicators, horn and brake lights operational.



WARNING:

When the engine is not running the steering and brakes will no longer be power-assisted. Therefore, be prepared for relatively heavy steering and the need for greatly increased brake pedal pressure.

6-10 Roadside emergency

Transporting

When the vehicle is being transported on a trailer or vehicle flat bed transporter, the handbrake must be applied, the wheels chocked and:

- the automatic gear selector lever moved to position 'N' or 'D' but NEVER to 'P'.
- the manual gear selector lever moved to the neutral position.

The vehicle must be securely tied down to the transporter or trailer. There are four transporter tie-down brackets on the vehicle underbody. Do not attach tie-down hooks to the towing eye.

Suspended towing

Ensure that the recovery team do not tow with sling-type equipment since damage to the bodywork may result.

Caution: Do not tow the vehicle with the front wheels lifted unless the propshaft to the rear wheels is disconnected at the final drive flange. If the propshaft is not disconnected, the rotating rear wheels will force the front wheels to rotate, even with the gear selector in neutral.

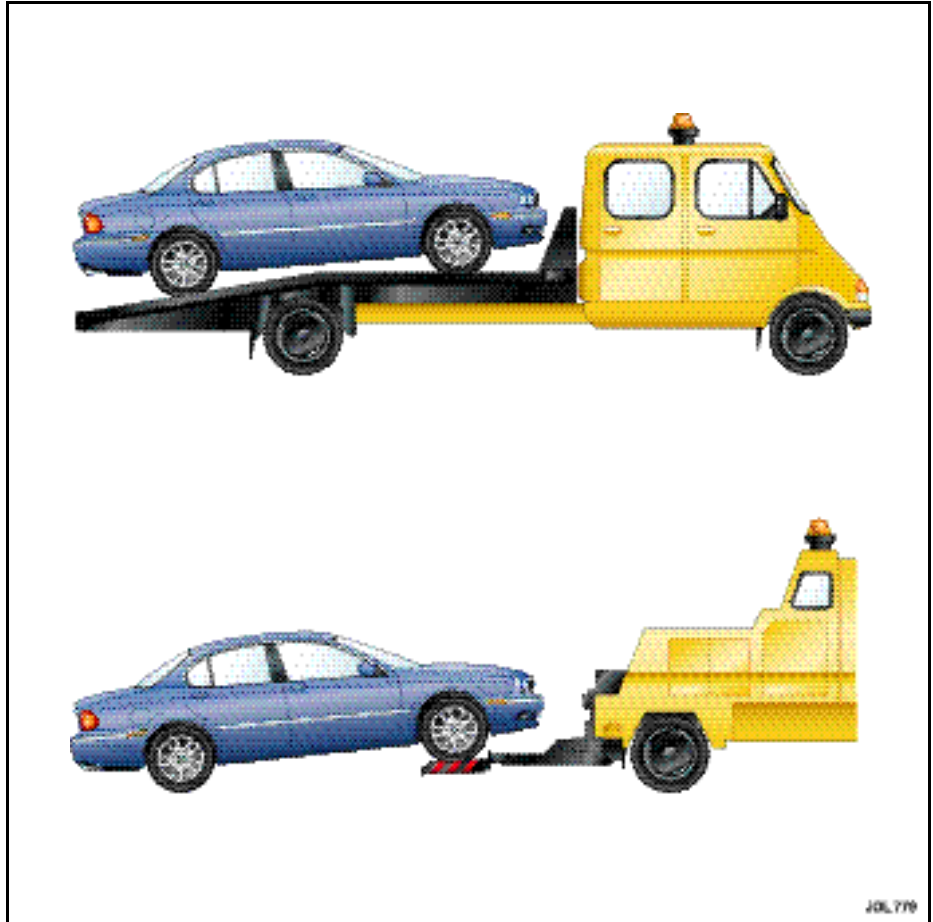

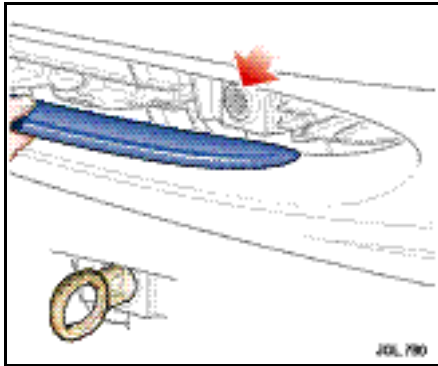

Towing eye

A towing eye is provided in the luggage compartment with the jack.

Caution:

- The towing eye is not suitable for 'solid bar' towing
- Care must be taken to avoid damaging the bumpers and front apron.

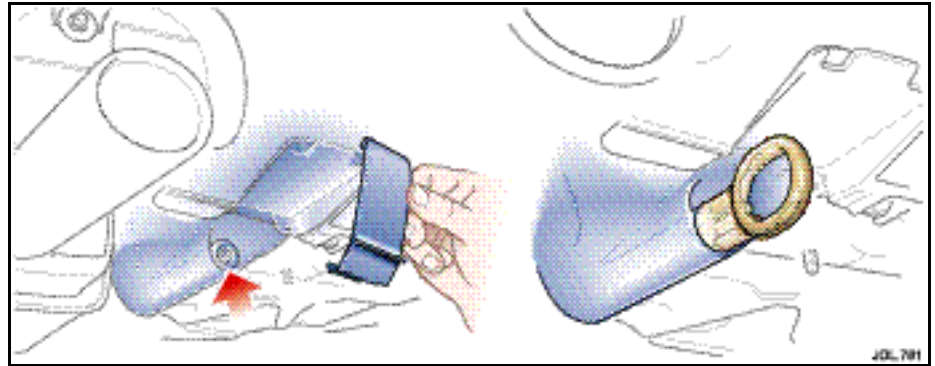

The front towing point is located at the right-hand side of the vehicle, in the grille. To prevent damaging them, the grille vane and the small cover on the left-hand side of the grille must be removed.

Pull the grill vane to remove it from the vehicle. Pull the small cover from the vehicle.

Screw the towing eye into the vehicle, right up to the shoulder.



WARNING:

Avoid body contact with a hot exhaust pipe when fitting the eye to the rear towing point.

The rear towing point is alongside the left-hand exhaust pipe.

Remove the small cover from the bumper. Remove the bung and screw the eye into the vehicle, right up to the shoulder.

6-12 Roadside emergency

Bulb renewal

It is important that only Jaguar bulbs of the type specified are used when renewing bulbs.

Before renewing bulbs, switch off the ignition and light switches.

Caution: Halogen type bulbs will be damaged if touched by hand or contaminated with oil or grease. It is important to use clean gloves or cloth when handling a bulb which is to be used again. A contaminated bulb may be cleaned with methylated spirit before refitting.

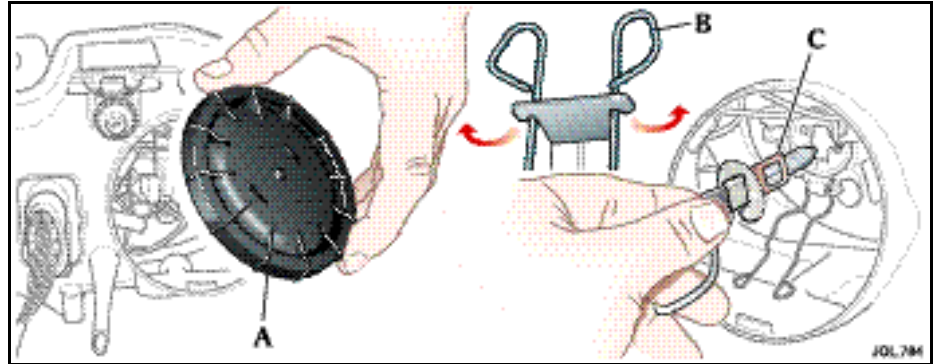

Main beam (inner) headlight

Open the bonnet.

Turn the circular cover (A) anti-clockwise and remove.

Press the spring clip (B) towards the bulb and downwards to release the bulb.

Remove the bulb/connector (C) from the headlight assembly. Pull the connector from the bulb.

Attach the connector to the new bulb, type H1 for main beam, and fit to the headlight. The bulb will only correctly fit in one position.

Engage the spring clips to retain the bulb and then fit the circular cover.

Refit the top cover and close the bonnet.

It is advisable to have the headlight aim checked by a Dealer after bulb renewal.



Dip beam (outer) headlight

Open the bonnet.

Slide open the two spring clips and remove the cover.

Press the spring clip inwards and push towards the bulb to release the bulb and then remove the bulb from the light unit.

Fit a new bulb to the holder, type H1 for dipped beam.

Fit the holder to the light unit, the bulb will only correctly fit in one position.

Engage the spring clips to retain the bulb and then fit the cover and retain using the two spring clips.

Close the bonnet.

Note: High Intensity Discharge (HID) Xenon light units, type D2S 35W, are not renewable, contact your Dealer if the headlight fails to operate.

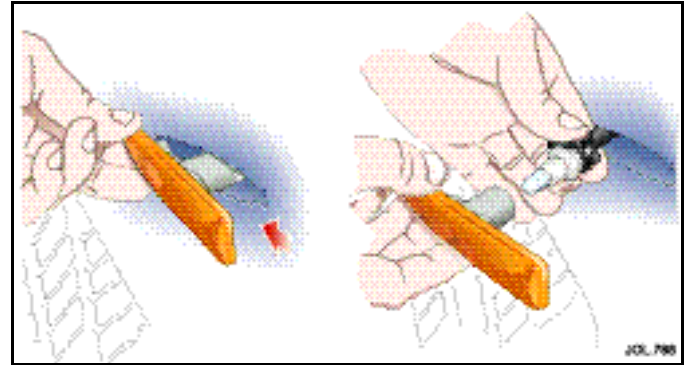

Side repeater indicator- bulb renewal

Remove the light unit by pushing the lens towards the front of the vehicle to compress the spring clip and then pull the rear outwards to remove the complete unit.

Twist the bulb holder anti-clockwise and pull it from the lens. Pull the capless bulb from the holder and fit a new one of the correct type, W5W. Fit the bulb holder to the lens.

Place the inner rear of the lens unit into the recess and then push the front of the lens inwards until it clicks into place.

6-14 Roadside emergency

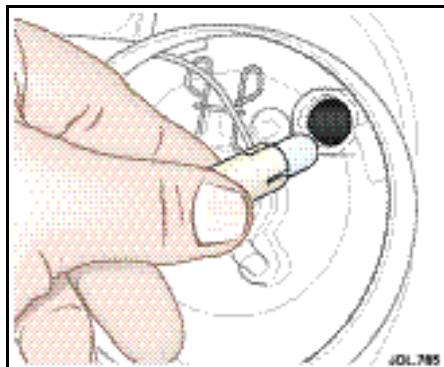

Front parking (side) light – bulb renewal

Open the bonnet.

The front parking lights are contained within the inner headlight units.

Turn the circular cover anti-clockwise and remove.

Pull the small bulb holder from the light unit.

Pull the capless bulb from the holder and fit a new one of the correct type, W5W.

Push the bulb holder into the headlight unit.

Fit the circular cover.

Close the bonnet.

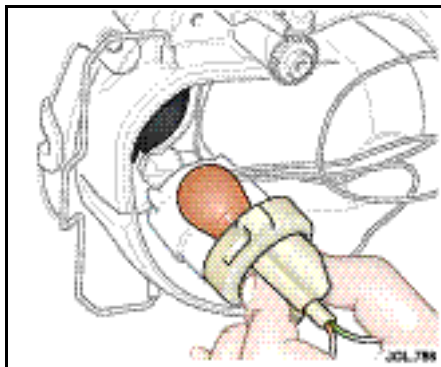

Front direction indicator – bulb renewal

Open the bonnet.

The bulb is contained within the outer headlight.

Slide open the two spring clips and remove the cover.

Turn the holder a quarter turn anti-clockwise and remove the bulb and holder.

Remove the bulb and fit a new one of the correct type, PY21W.

Fit the holder to the light unit, it will only fit in one position.

Fit the cover and retain using the two spring clips.

Close the bonnet.

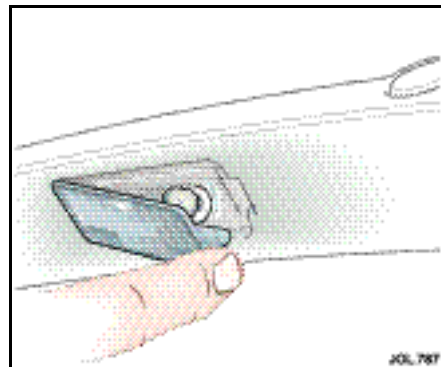

Number plate light – bulb renewal

Push the lens clip sideways and remove the lens from the vehicle.

Remove the bulb and fit a new one of the correct type, W5W.

Refit the lens by pressing it firmly into the recess until it clicks into place.

Front fog light – bulb renewal

It is recommended that the front fog light bulb, type H1, is renewed by a Jaguar Dealer.

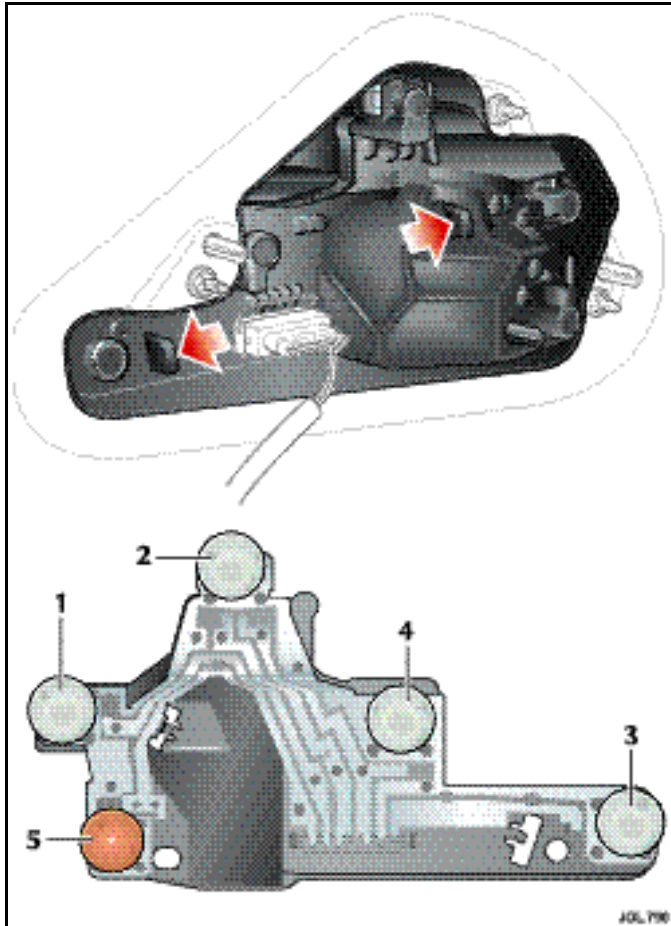

Rear light assembly– bulb renewal

The rear light assembly has the following bulbs:

1. Reverse light, type P21W.
2. Stop/tail light, type P21/5W.
3. Fog light, type P21W.
4. Tail light, type P21/5W.
5. Direction indicator, type PY21W.

Ensure that the lights and ignition switch are OFF before removing any bulbs.

Open the luggage compartment, loosen the side carpet and unclip the rear light bulb carrier.

Remove the faulty bulb and fit a new one of the correct type, as illustrated on the bulb holder. Fitment of the correct type is essential.

Refit the bulb carrier assembly, ensuring that the clips are correctly secured.

Refit the carpet.

High mounted stop light

The high mounted stop light is an LED type. Should one or more LED's fail then the unit may cease to meet legal requirements and must be renewed immediately by a Jaguar Dealer.

6-16 Roadside emergency

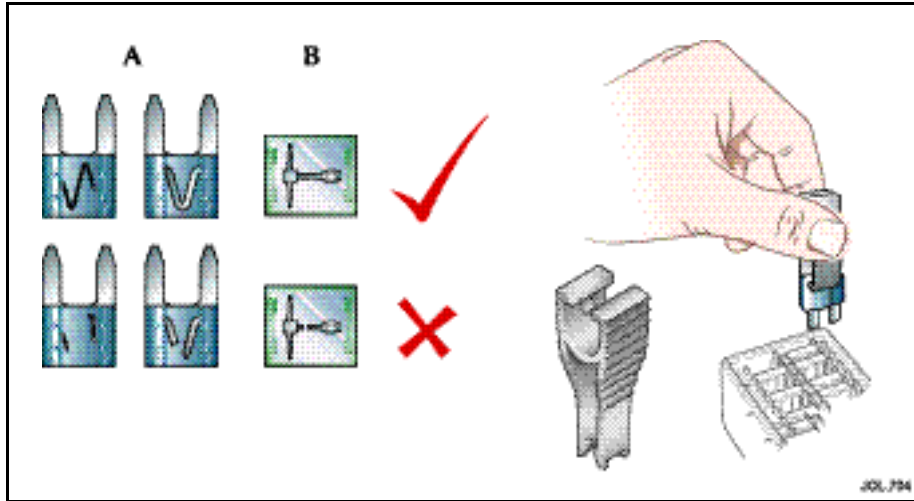

Fuses and fuse boxes

Fuse failure is identified by an inoperative circuit.

Do not fit a new fuse if the wiring is damaged; contact a Jaguar Dealer. After renewing a fuse have the circuit checked by a Jaguar Dealer.

Two types of fuses are fitted in the fuse boxes, a mini-type (A) and a cartridge-type (B).

A special tool for removing and replacing the mini-fuse is provided in the engine compartment fuse box lid, together with spare fuses.

Use only the spare fuses supplied. If a spare fuse is used, renew it with a Jaguar approved fuse of the **same** amperage rating.

Checking and renewing a blown fuse

Make sure the new fuse is the correct rating (amperage).

Fuses are colour coded according to the amperage and the rating is also marked on each fuse.

Mini-fuse replacement

Push the tool on to the suspect mini-fuse and withdraw it.

If the wire in the fuse is broken, the fuse has blown.

Fit a new fuse using the tool.

Cartridge fuse replacement

Pull the suspected blown fuse from its holder.

If the wire in the fuse is broken, the fuse has blown.

Push a new fuse into the holder.



WARNING:

- 1. Do not fit a fuse of a different amperage from that removed. The electrical circuits may become overloaded with the subsequent possibility of a fire.**
- 2. No attempt should be made to repair a fuse that has blown as this may cause a fire hazard or serious damage elsewhere in the electrical circuit.**

Fuse box locations

There are two separate fuse boxes fitted to the vehicle, each one containing fuses protecting a different group of circuits.

They are located in:

- A.** the engine compartment
- B.** the passenger compartment

Caution: When a fuse box lid is removed, take care to protect the box from moisture, and refit the lid at the earliest opportunity.

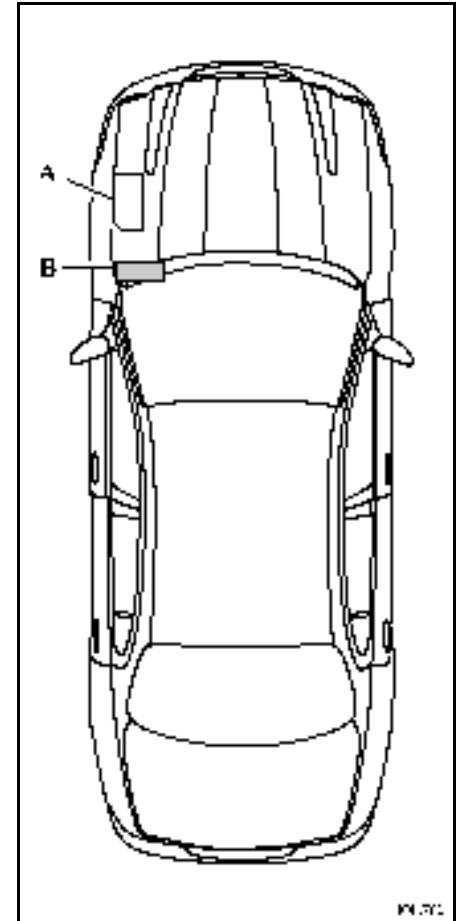

6-18 Roadside emergency

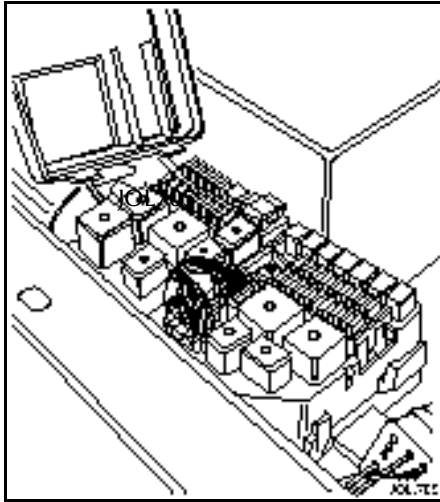

Engine compartment fuse box

The fuse box is located in the engine compartment on the left-hand side adjacent to the battery.

Remove the fuse box lid by pressing the retaining lugs and lifting.

A tool for removing the mini-fuses is located in the fuse box cover.

When refitting, press the fuse box lid in the area of the retaining lugs until the lid engages.

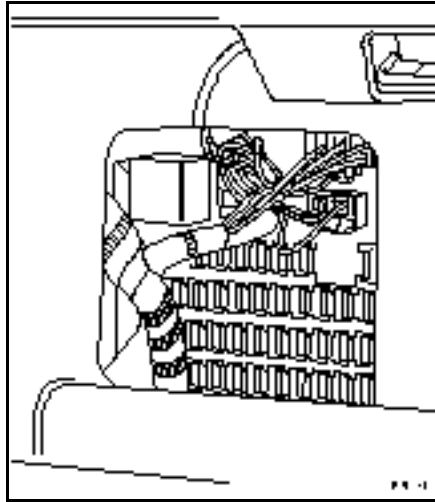

Passenger compartment fuse box

The passenger compartment fuse box is located on the left-hand side of the vehicle, against the bulkhead.

A tool for removing the mini-fuses is located in the engine compartment fuse box cover.

Right-hand drive vehicles

To gain access to the fuse box, open the glove compartment and remove the panel at the front of the compartment.

Left-hand drive vehicles

For fuse box visual access, remove, by unclipping/pulling, the sunglasses storage compartment, to the left of the steering column.

A torch or flashlight will be required to properly identify the fuses.

Fuse and Relay Positions

A- Engine compartment fuse box

B - Passenger compartment fuse box

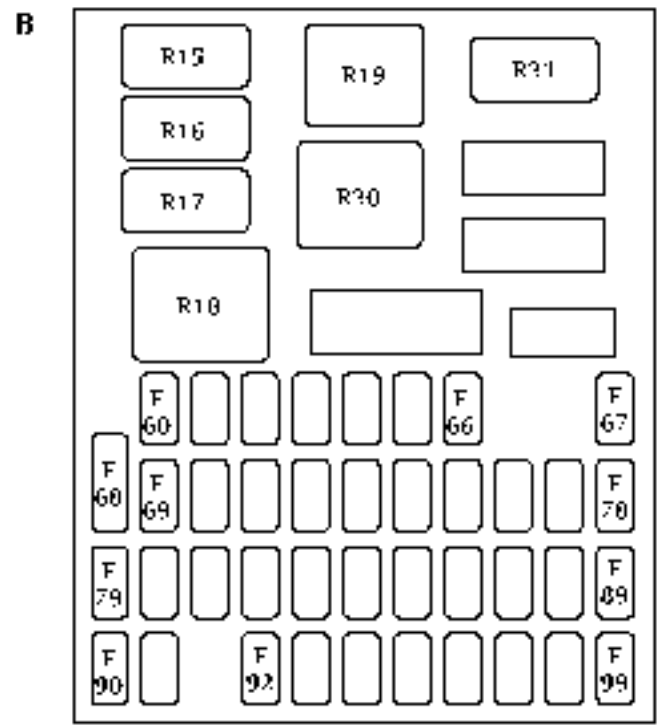
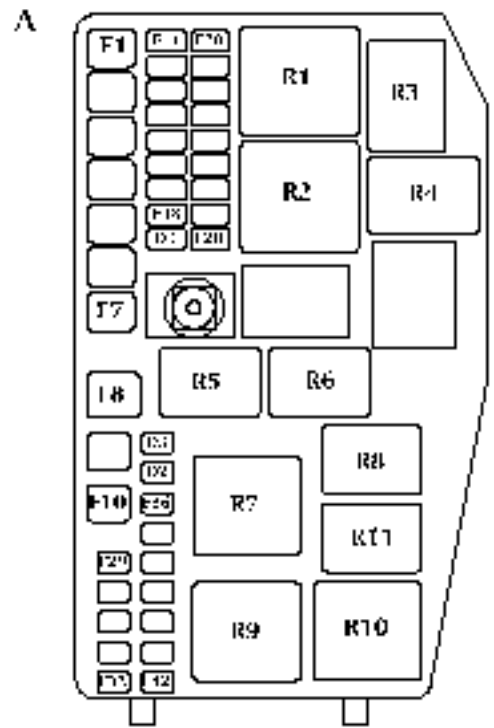

6-20 Roadside emergency

Engine compartment fuse box – fuses

Fuse No	Fuse Type	Rating (amps)	Colour	Circuit
F1	cartridge	20	Blue	Dip beam, High Intensity Discharge(HID) light relay.
F2	cartridge	50	Red	Ignition relay feed.
F3	cartridge	60	Yellow	ABS.
F4	cartridge	30	Pink	Rear window heater relay, heated mirrors.
F5	cartridge	30	Pink	Auxiliary vacuum pump, transmission control module.
F6	cartridge	30	Pink	Heater blower relay.
F7	cartridge	50	Red	Power supply to passenger compartment fuse box.
F8	cartridge	80	Black	Fan module.
F9	cartridge	50	Red	Engine management system power relay, headlight power wash.
F10	cartridge	20	Blue	Headlight power wash relay.
F11	mini			Not used.
F12	mini			Not used.
F13	mini	30	Green	Heated front screen right-hand side.
F14	mini			Not used.
F15	mini	30	Green	Heated front screen left-hand side.
F16	mini	20	Yellow	Left-hand dip beam, DTRL, autolights.
F17	mini	20	Yellow	Right-hand dip beam, HID lights.

Roadside emergency 6-21

Fuse No	Fuse Type	Rating (amps)	Colour	Circuit
F18				Not used.
F19	Diode D1			Not used.
F20	Mini	5	Tan	Navigation display.
F21	Mini	15	Blue	Master lighting (Park lights).
F22	Mini	20	Yellow	Accessory relay.
F23	Mini	10	Red	Air conditioning compressor clutch relay.
F24	Mini	15	Blue	Door lock power.
F25	Mini	15	Blue	Direction indicators (GEM).
F26	Mini	15	Blue	Horns relay.
F27	Mini	10	Red	Transmission control module, transit relay.
F28	Mini	30	Green	Ignition switch.
F29	Mini	30	Green	Starter motor relay.
F30	Mini	30	Green	Accessory sockets.
F31	Mini	10	Red	Engine management relay coil.
F32	Mini	5	Tan	Engine management control.
F33	Mini	20	Yellow	Throttle motor relay.
F34	Diode D3			Not used.
F35	Diode D2			Diode EMS relay.

6-22 Roadside emergency

Fuse No	Fuse Type	Rating (amps)	Colour	Circuit
F36	Mini	10	Red	Canister purge valve, canister close valve, airflow meter, throttle motor relay, power wash relay coil, air conditioning relay coil.
F37	Mini	15	Blue	Engine management system, fan speed controller, speed controller.
F38	Mini	30	Green	Oxygen sensor heatersA.
F39	Mini	5	Tan	Variable intake valves.
F40	Mini			Not used.
F41	Mini	10	Red	Injectors.
F42	Mini	30	Green	Oxygen sensor heatersB.

Engine compartment fuse box – relays

Fuse No	Fuse Type	Rating (amps)	Colour	Circuit
R1	ISO 40 A	40A	Black	Windscreen wipers.
R2	ISO 70 A	70A	Grey	Heated front windscreen.
R3	Micro 20 A	20A	Black	Horn.
R4	Micro 20 A	20A	Black	Accessories.
R5	Micro 20 A	20A	Black	Headlight powerwash.
R6	Micro 20 A	20A	Black	Air conditioning compressor clutch.
R7	ISO 70 A	70A	Grey	Engine management system.
R8	Micro 20 A	20A	Black	Transmission control module.
R9	Micro 20 A	40A	Black	Dip beam/HID.
R10	ISO 40 A	40A	Black	Starter motor.
R11	Micro 20 A	20A	Black	Throttle motor.

6-24 Roadside emergency

Passenger compartment fuse box – fuses

Fuse No	Fuse Type	Rating (amps)	Colour	Circuit
F60	Mini	20	Yellow	Power windows left-hand.
F61	Mini	20	Yellow	Power windows right-hand.
F62	Mini	10	Red	Rear fog lights.
F63	Mini	10	Red	Right-hand– front side light, side markers, rear tail lights.
F64	Mini	10	Red	Left-hand – front side light, side markers, rear tail lights.
F65	Mini			Not used.
F66	Mini	30	Green	Left-hand power seat switches and heater module.
F67	Mini	5	Tan	Battery back-up sounder, transit relay, HID/dip relay, auxiliary vacuum pump control.
F68	Mini	15	Blue	Cigar lighter.
F69	Mini	10	Red	In-car entertainment head unit, antenna module, navigation module, VICS, tuner, voice module, parking aid, amplifier premium 1 system, phone handset, phone power supply module, instrument cluster, PATS module.
F70	Mini	30	Green	Right-hand power seat switches and heater module.
F71	Mini	15	Blue	VICS (Japan), voice module, telephone transceiver, telephone handset.
F72	Mini	15	Blue	Radio head unit, CD player, navigation electronic control module, Jaguardiagnosticconnector/OBD2 connector.
F73	Mini	15	Blue	Sunroof unit/module.
F74	Mini	15	Blue	Instrument cluster, Premium ICE amplifier unit.

Fuse No	Fuse Type	Rating (amps)	Colour	Circuit
F75	Mini	10	Red	Mirror fold-back module, battery back-up sounder, air conditioning ECU.
F76	Mini			Not used.
F77	Mini	10	Red	Screenwash pump, rain sense.
F78	Mini	5	Tan	Phone power supply, Jaguar Telematics.
F79	Mini	10	Red	Reverse lights, reverse light switch, reverse park aid, electrochromic mirror, instrument cluster.
F80	Mini	10	Red	Park interlock, heater switch, OBD2, blower relay.
F81	Mini	20	Yellow	Fuel pump.
F82	Mini	20	Yellow	Manual transmission reverse lights, variable power steering, alternator, TCM.
F83	Mini	10	Red	Left-hand and right-hand heated seats modules.
F84	Mini	5	Tan	Instrument cluster, pad light, seat weight sensor.
F85	Mini	10	Red	Right-hand high beam light.
F86	Mini	10	Red	Left-hand high beam light.
F87	Mini	15	Blue	Front fog lights, master light switch.
F88	Mini			Not used.
F89	Mini			Not used.
F90	Mini	15	Blue	Stop lights, cruise control.

6-26 Roadside emergency

Fuse No	Fuse Type	Rating (amps)	Colour	Circuit
F91	Mini	10	Red	Sunroof, electrochromic mirror, left and right-hand power windows.
F92	Mini	10	Red	Manual transmission cruise control switch, ignition coils, automatic transmission rotary switch.
F93	Mini	30	Green	Windscreen wipers.
F94	Mini	20	Yellow	HID module.
F95	Mini	10	Red	Airbag restraints module.
F96	Mini	10	Red	ABS module.
F97	Mini	10	Red	Glove compartment light, instrument cluster lights, licence plate lights.
F98	Mini	10	Red	Mirror heaters.
F99	Mini	10	Red	Footwell lights, luggage compartment light, puddle lights, vanity mirror lights, interior lights, aircon control unit, roof console unit.

Passenger compartment fuse box- relays

Relay No	Type	Rating (amps)	Colour	Circuit
R15	Micro 20 A	20A	Black	High beam/front fog lights relay.
R16	Micro 20 A	20A	Black	Not used.
R17	Micro 20 A	20A	Black	Reverse lights.
R18	ISO 70 A	70A	Grey	Ignition relay.
R19	ISO 40 A	40A	Black	Heated rear window relay.
R20	ISO 40 A	40A	Black	Blower relay.
R21	Micro 20 A	20A	Black	Battery saver relay.

General maintenance

Precautions

- Ensure that the vehicle is securely supported before working underneath it. Chock a front wheel and apply the handbrake.
- Whenever possible use a suitable wheel-free lift when working beneath the vehicle. If a jack is used to support the vehicle, use axle stands carefully placed at the jacking points to provide a rigid support. Only use jacking equipment at the designed lifting points.
- Ensure that adequate ventilation is provided when volatile degreasing agents are being used.
- Never use volatile cleaning fluids under a vehicle standing over a pit. Many such fluids give off vapours which are heavier than air and dangerous to inhale.

- Wear protective overalls, ensure loose clothing (ties, etc.) are removed or covered when working adjacent to moving components (fan belts, etc.).
- Do not leave opened containers of oil, fuel, etc., about the work area. Always refit caps/seals to partially used containers when storing them for later use.
- Do not leave tools, equipment, spilt oil, etc., around or on the work area.
- Place a fire extinguisher close to the vehicle and disconnect the negative battery terminal.

Note: On battery reconnection, the radio code will be required, the clock must be reset and the electrically operated door windows reset to restore the anti-trap feature.

- Do not use a naked flame to provide illumination, especially under the vehicle, or in the engine and luggage compartments. Do not smoke while working on the vehicle.
- Do not apply heat in an attempt to free nuts or fittings. This will damage protective coatings and there is a risk of damage to electronic equipment and brake and fuel lines from conducted heat.
- Inspect power leads of any mains electrical equipment for damage, and check that it is properly earthed.

7-2 Maintenance

General precautions against damage

- When working in the engine compartment protect the exterior paintwork by using suitable covers over the wings and scuttle.
- To prevent soiling the interior, carry out jobs requiring access to the passenger or luggage compartments first. If a job involves access to the interior in the course of other work, prevent the transfer of oil and grease to the interior by using seat and carpet covers and wearing clean overalls and gloves. If protective seat covers have been used they must be removed before the vehicle is driven on the public highway to ensure that, if needed, the side airbags can properly deploy.
- Always use a recommended service tool, where specified.
- Avoid spilling hydraulic fluid or battery acid on paintwork. Wash off with water immediately if this occurs.

Battery/ignition isolator switches

Non-approved battery isolator switches, which disconnect the power supply to all electrical circuits, are not recommended.

Used Engine Oil



WARNING:
Prolonged and repeated contact may cause serious skin disorders, including dermatitis and cancer.

Always use a hand cream to protect the skin from oil contamination. Avoid contact with the skin as far as possible and wash thoroughly after any contact. Keep oils out of reach of children.

PROTECT THE ENVIRONMENT: It is illegal to pollute drains, watercourses and soil. Use authorised waste collection facilities, including civic amenity sites and garages providing facilities for the disposal of used oil, oil filters and batteries. If in doubt, contact your Local Authority for advice on disposal.

Engine and throttle settings

Do not attempt to make adjustments to the engine or throttle settings. Many vehicle systems are controlled by complex electronic devices and require specialist knowledge. Such work should be entrusted to a Jaguar Dealer.

Hydraulic fluid

The brake hydraulic fluid in the master cylinder and brake operating system uses non-mineral polyglycol based brake fluid with a minimum standard of JAGUAR SUPER DOT 4. ONLY FLUID OF THIS TYPE AND STANDARD MAY BE USED.



WARNING:
Contamination of the brake system fluid by as little as 1 per cent will cause rapid deterioration of the system seals. Ensure that the brake fluid reservoir cap is securely fitted.

Bonnet release



WARNING:

Take care to keep away from rotating components if the engine is running when you open the bonnet.

Release the bonnet lock by pulling the lever below the fascia on the left-hand side of the vehicle.

Lift the bonnet slightly and pull up the safety catch under the bonnet, located centrally behind the grille. The gas filled struts will assist raising the bonnet, and retain it in the fully open position.



WARNING:

Before closing the bonnet ensure that no one is obstructing the closing area and that hands and clothes are clear. Remove tools, cleaning cloths, etc., from the engine compartment.

Bonnet closing

Close the bonnet to within a distance of 10 to 12 inches (250 to 300 mm) of the fully closed position, then let go to allow the bonnet to shut. Check by pulling the bonnet that both the right-hand and left-hand latches are engaged.

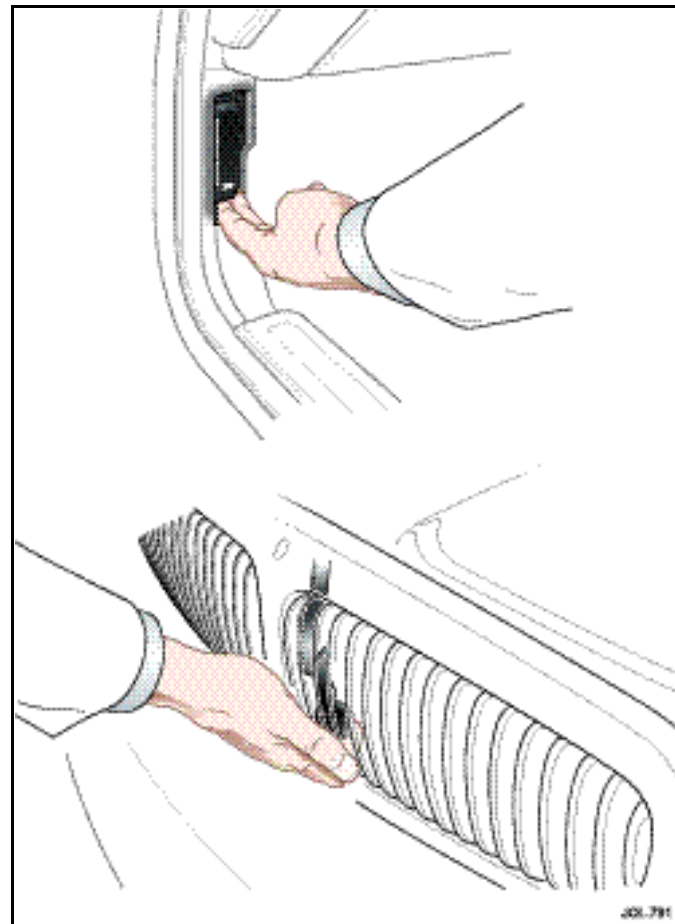

7-4 Maintenance

Regular checks

In the interests of safety and reliability, it is advisable to carry out the following checks at the recommended intervals, and always before starting on a long journey.

Daily

Check that there is sufficient fuel for the journey intended, particularly at night and before entering motorways.

Weekly

Tyres – Check the tyres, including the spare, for condition and pressure. Tyre pressures are shown inside the front cover of this handbook.

Lights – Check that all exterior lights and direction indicators function correctly and that the lenses are clean.

Engine oil – With the vehicle standing on level ground, check the oil level and replenish if necessary with oil of the correct grade.

Engine coolant – With the engine cold, check the level of the coolant in the coolant reservoir header tank. Any loss of fluid must be checked by a Jaguar Dealer.

Brake/clutch fluid – Check the level of the fluid in the brake fluid reservoir. Replenish if necessary with new, unused Jaguar approved brake fluid.

The reservoir is initially nearly full, but the level will drop as the brake pads wear. If the level appears unusually low, location of the fluid leakage must be checked by a Jaguar Dealer.

Power steering fluid – With the engine cold check the level of the fluid in the power steering fluid reservoir. Replenish if necessary with fluid of the correct specification. Any loss of fluid should be checked by a Jaguar Dealer.

Monthly

Windscreen washer fluid – Replenish with recommended windscreen washer fluid and clean soft water. Check the operation of the washer. Use Jaguar Windscreen Washer Fluid to keep the glass clean and also to prevent the fluid from freezing during cold weather.

Wiper blades – Check the quality of the wipe. If smearing or juddering is evident, clean the windscreen and renew the wiper blades.

Reservoir and dipstick locations

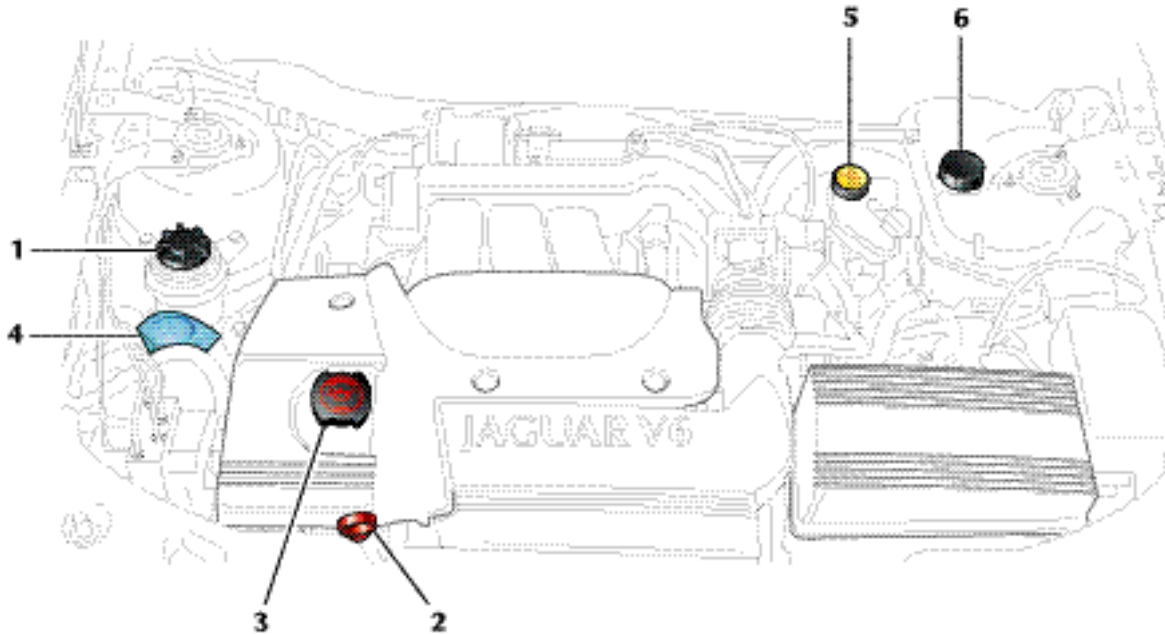

1. Power steering reservoir
2. Engine oil dipstick
3. Engine oil filler

4. Windscreen wash reservoir
5. Brake/clutch reservoir
6. Coolant reservoir

7-6 Maintenance

Checking and replenishment

Check engine oil level

Check the oil level regularly with the vehicle on flat, level ground.

Refer to page7-5 for dipstick and oil filler locations.

It is preferable to check the oil level after the vehicle has been standing, that is, with the engine completely cold.

If the engine has been started do not check the oil level until the engine has reached normal operating temperature. Stop the engine and wait for a minimum of 5 minutes to allow the oil to drain back into the sump.

Remove the dipstick (A) and wipe clean with a non-fluffy cloth. Replace fully, then withdraw the dipstick. If the oil level is above the lower of the two dots on the dipstick then no additional oil is required.

If the oil level reaches the lower of the two dots, remove the oil filler cap (B) and add oil, to the quantity and specification shown on the next page.

Refit the filler cap and hand tighten securely.

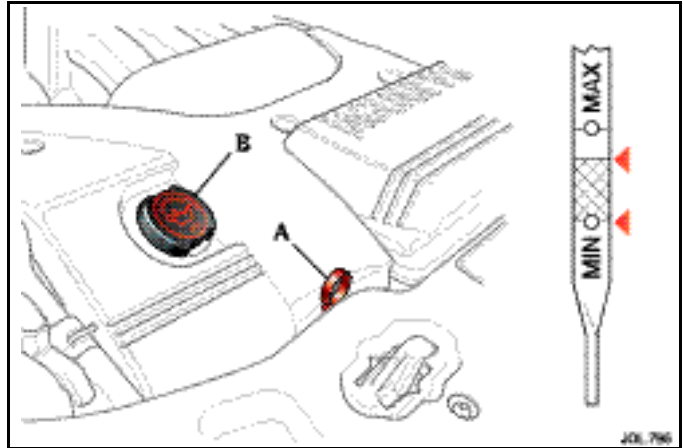

Recommended engine oil

When the oil level is at the lower dipstick mark, add one litre of oil:

Oil specification – API SJ / EC and ACEA A1-98 or A3-98.

SAE Viscosity Rating

Recommended SAE Viscosity Range / Ambient Temperature Scale

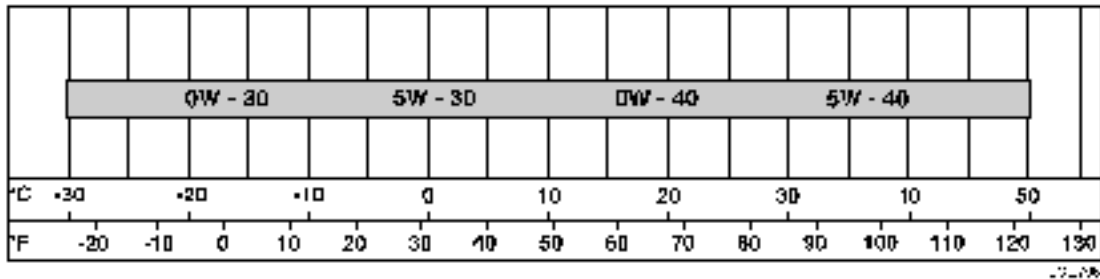

7-8 Maintenance

Check power steering fluid level

Caution: It is imperative that the power steering system does not become contaminated in any way. Always dispense fluid from a fresh sealed container and clean the area around the reservoir neck both before and after replenishment. Never return drained fluid to the system.

Refer to page 7-5 for power steering fluid reservoir location.

Check the fluid level when the engine is 'COLD' and the vehicle is on a flat, level surface.

Wipe clean and remove the filler cap from the reservoir; take great care to prevent any foreign matter from entering. Check that the fluid level is between the marks on the dipstick.

If necessary, replenish with power steering fluid to specification **Dexron IIE**, DO NOT OVERFILL.

Refit the filler cap.

Should the level be very low, report the loss of fluid to the nearest Jaguar Dealer.

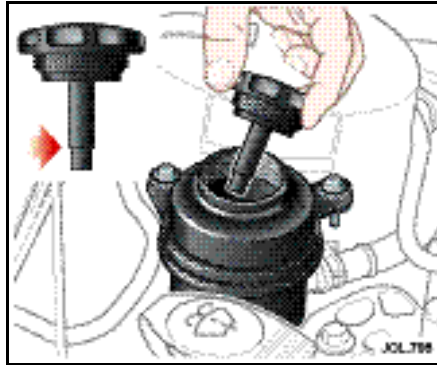

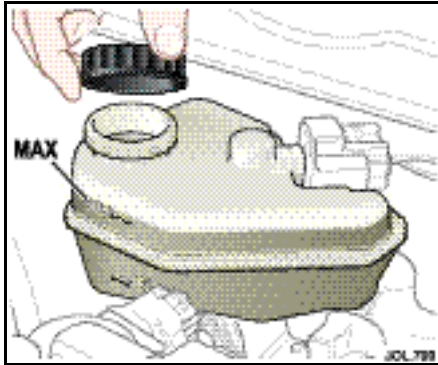

Check brake/clutch fluid reservoir

The manual transmission clutch fluid is shared with the brake fluid in a common reservoir.



WARNING:

The fluid level will drop as the brake pads wear. If the level is very low report the loss of fluid to the nearest Jaguar Dealer. Do not drive the vehicle until the cause is rectified.

Caution:

- 1. While handling brake fluid, take extreme care; brake fluid must not contact the vehicle paintwork.**
- 2. Always use fresh, clean fluid from a new container. Never introduce used brake fluid into the system.**

Refer to page 7-5 for brake/clutch fluid reservoir location.

The fluid is visible through the translucent casing of the reservoir and must be maintained at the 'MAX' mark.

If necessary, replenish as follows:

Before removing the cap, clean the reservoir and cap thoroughly with a non-fluffy cloth to ensure that no foreign matter enters the reservoir.

Unscrew the filler cap and replenish to the 'MAX' level using brake fluid to specification **Jaguar Super DOT 4 (ESA-M6C25-A)**.

Refit the filler cap securely.

To avoid contamination should any brake fluid be spilt, replace the cap on the reservoir before cleaning the spilt fluid from the vehicle.

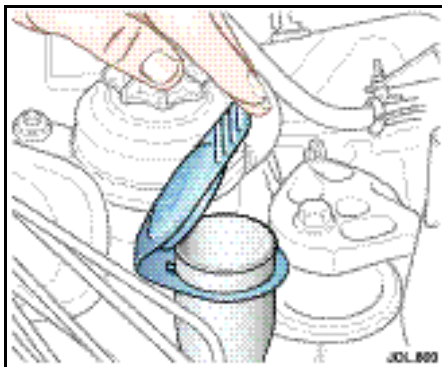

Check windshield washer reservoir

Refer to page 7-5 for windshield washer reservoir location.

The washer reservoir contains the fluid for the windshield washers and the headlamp powerwash system.

Fill to just below the neck with Jaguar Windscreen Washer Fluid diluted with clean, preferably soft water as specified in the instructions on the bottle.

Do not over-fill.

Note: Using a non-approved fluid may adversely affect the wiper blade rubber, resulting in ineffectual and noisy wiping.

Cold weather precautions

To prevent damage to the pump during freezing conditions, use Jaguar Windscreen Washer Fluid at the strength shown on the bottle, for the anticipated ambient temperature.



WARNING:

Windscreen washer fluid is toxic and in concentrated form is flammable. Be sure to observe all warnings indicated on the washer solution container.

Under no circumstances must cooling system anti-freeze be used, since this will damage the paintwork.

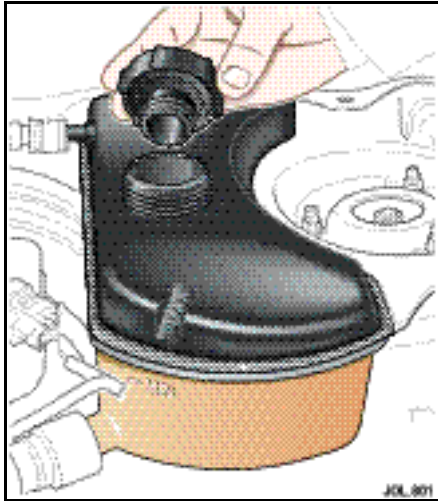

Check coolant level

The coolant level must only be checked when the engine is COLD.

Refer to page 7-5 for coolant header tank location.



WARNING:

Do not remove the coolant header tank filler/pressure cap while the engine is hot. If the cap must be removed, protect the hands against escaping steam and slowly turn the cap anti-clockwise until the steam pressure starts to escape. Leave the cap in this position until the pressure is released, and then remove the cap completely.

The coolant level should be between the two marks located on the side of the header tank. If persistent coolant loss is noticed, report this to a Jaguar Dealer to have the cause investigated at the earliest opportunity.

Replenishing



WARNING:

Do not allow anti-freeze to make contact with skin or eyes. If this should happen, rinse the affected area immediately with plenty of water.

Caution: Anti-freeze will damage paintwork. Avoid spillage.

Replenish with the correct strength anti-freeze and water, (see next page), until the coolant is within the 'max' and 'min' marks on the header tank.

Refit the filler cap and hand tighten securely until the ratchet operates.

7-12 Maintenance

Engine anti-freeze

Anti-freeze, when used at the correct concentration, not only protects the engine from frost damage in winter, it also provides all year round protection against internal corrosion.

The cooling system should be filled or replenished with a mixture of 50percent water and 50percent anti-freeze, conforming to specification:

WSSM97B44-D, coloured orange,
Extended Life Coolant.

This mixture gives frost protection for temperatures down to -40°C (-40°F).

Do not mix any other anti-freeze with that specified; inferior quality anti-freeze may be ineffective in maintaining adequate frost and corrosion protection to the cooling system.

The coolant solution may remain in the cooling system for five years or 156,000miles (250,000 km) after which the system should be drained, flushed and refilled.

Engine block heater

For further information consult your Jaguar Dealer.

Caution: The fitting of an engine block heater does not eliminate the need for anti-freeze under freezing conditions.

Capacities

	Litres	Imperial Pints	US Quarts
Engine oil, including oil filter.	6.5	11.4	6.9
The rear axle (final drive unit), transfer box and automatic and manual transmission units (gearboxes) will not normally require to be checked or replenished.			
Cooling system, including reservoir and climate control	8,25	14.4	8.7
Windscreen washer reservoir			
– without headlamp powerwash	2,5	4.4	2.6
– with headlamp powerwash.	6,0	10.5	6.3

Fuel Tank

	Litres	Imperial Gallons	US Gallons
Fuel tank capacity	61,5	13.5	16.2

Battery

A low maintenance battery specifically designed for use with this vehicle is fitted in the engine compartment.



WARNING:

- 1. The cell plugs and vent pipe must be in place at all times when the battery is in the vehicle. Failure to fit, or incorrect fitting of these items is potentially hazardous.**
- 2. To avoid injury do not use an open flame or cause an electric spark when checking the battery. Hydrogen gas generated by the battery is flammable and may explode.**
- 3. Do not connect any 12volt equipment, (for example, a 12volt lead lamp), directly to the battery terminals. Use the cigar lighter sockets for temporarily connecting Jaguar approved accessories.**

- 4. Do not let battery acid electrolyte come into contact with skin or eyes. If you get any in your eyes or on your skin, immediately rinse with cold water and consult a doctor.**

Caution:

- 1. Switch off ignition before disconnecting battery terminals. Always disconnect the earth terminal first and reconnect last.**
- 2. Do not let battery acid come into contact with painted surfaces or fabric.**

The exterior of the battery should be occasionally wiped clean to remove any dirt or grease.

If a new battery is to be fitted, it must be the same type as the original.

The use of unapproved batteries is not recommended and could invalidate the vehicle warranty.

Note: The service life of the battery is dependent on its condition of charge. It must always be sufficiently charged for the battery to last an optimum length of time. We recommend that the battery charge is checked frequently if the vehicle is used mostly for short distance trips, or if it is not used for long periods of time.

Alternator

To prevent damage to the alternator, do not run the engine while the battery or any of the charging circuit cables are disconnected.

The alternator has polarity-sensitive components that may be irreparably damaged if subjected to incorrect polarity. Ensure that the battery earth lead is always connected to the battery negative terminal.

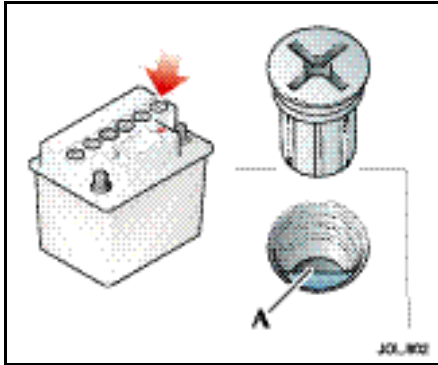

Check/replenish battery electrolyte

Note: In normal climates this must be carried out at least once a year. In hot weather/climates the electrolyte level must be checked at least every three months.

Open the bonnet and remove the battery cover.

Unscrew the six cell plugs. Check that the electrolyte is level with the plastic level indicator (A). If necessary, replenish with distilled water but do not overfill.

If illumination is required, use a hand-held torch to inspect the electrolyte level.

Refit the six cell plugs and refit the battery cover.

Battery charging



WARNING:

Batteries produce combustible gas (hydrogen) when being charged. The battery must be removed from the vehicle before charging commences.

To disconnect the battery, refer to battery lead disconnection on the next page.

When charging the battery ensure that the charge voltage is the same as the nominal voltage of the battery.

Switch off the charger before connecting or disconnecting terminal connections to avoid sparks and short circuits.

Ensure that the charger positive (+) lead is connected to the positive (+) terminal of the battery and the negative (-) lead is connected to the negative (-) terminal of the battery.

Do not remove or loosen any of the cell plugs when charging the battery.

Check, and if necessary replenish, the electrolyte level when the battery is fully charged.

7-16 Maintenance

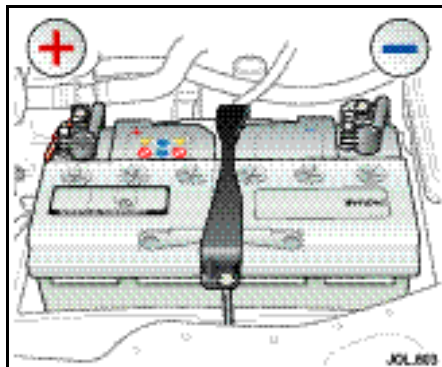

Battery lead disconnection

Note:

- Upon battery lead reconnection the radio security code will be required and the clock will need to be reset.
- Electrically operated door windows must be reset to learn the anti-trap function.
- If the battery is disconnected for more than 72hours the radio preset channels will need to be reset upon battery reconnection.
- The trip computer will lose all recorded trip data and all trip functions will be reset to zero. The vehicle total odometer reading is retained.

Caution:

1. Under no circumstances should a battery be disconnected whilst the ignition circuit is live, as permanent damage to the instrument cluster may occur.
2. Disconnect the negative lead (earth terminal) first.

Open the bonnet and unclip the battery box cover.

Slacken the negative lead pinch bolt and disconnect the negative(-) battery lead. Slacken the positive lead pinch bolt and disconnect the positive(+) battery lead.

Clean the battery posts and coat the post bases with petroleum jelly.

Battery lead connection

Note: Upon battery reconnection the security system will be armed. Opening any protected entry will sound the alarm. Make sure that a key or key transmitter is available.

Caution: Do not overtighten the pinch bolts.

Connect the positive (+) lead, tighten the pinch bolt and clip the positive terminal cover on the battery. Connect the negative (-) lead and tighten the pinch bolt.

After the battery has been reconnected and the ignition switch is turned to position 'II', the message centre display, if fitted, will initially show an erroneous reading i.e. -----. This will remain until after the bulb check sequence, when the correct recorded mileage will be displayed. This is a normal function of the instrument cluster.

Note: When the battery is disconnected and reconnected, some abnormal drive symptoms may occur while the vehicle relearns it's adaptive strategy. The vehicle may need to be driven 10 miles (16kilometres) or more to relearn the strategy.

Reset the clock to the correct time.

The radio will not operate until the correct security code has been re-entered. Refer to the Audio Systems Handbook.

Reset the window anti-trap feature.

Windscreen wipers

Note: Use Jaguar Screen Clean Paste to remove contamination from the windscreen to ensure effective wiping or if smearing or juddering becomes evident. A more aggressive cleaning agent may be required to remove stubborn contamination. Contact a Jaguar Dealer for advice.

To ensure that the windscreen remains smear free, the washer system should be operated whenever the wiper is used, even when it is raining.

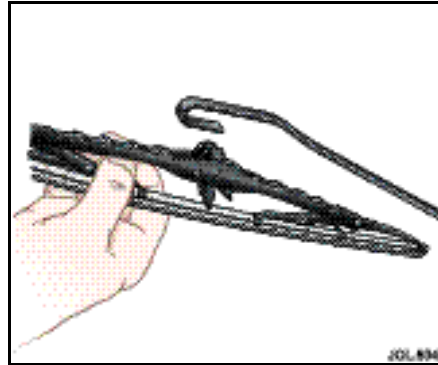

Windscreen wiper blades – inspect and clean

Lift the wiper blades clear of the windscreen and wipe the blades with a clean, soft cloth moistened with water to which a mild liquid detergent has been added.

Inspect the wiper blades, and if there any signs of wear or damage; renew the blades.

Renew the wiper blades before and after each winter, or more often if required.

Wiper blade renewal

Move the wiper arm away from the windscreen, squeeze the retaining clip and withdraw the wiper blade from the arm. After fitting the new blade, check that it is held firmly in position. Reposition the wiper arm and blade onto the screen.

Windscreen washers

Two windscreen washer nozzles are mounted on the bonnet. Each nozzle directs two spray patterns to the windscreen.

Note: The windscreen wiper jets and headlamp washer jets are not adjustable.

7-18 Maintenance

Tyres

Tyres of the correct type, manufacturer and dimensions, with correct cold inflation pressures are an integral part of every vehicle's design. Regular maintenance of tyres contributes not only to safety, but to the designed function of the vehicle. Road-holding, steering and braking are especially vulnerable to incorrectly pressurised, badly fitted or worn tyres.

Tyres of the correct size and type, but of different make have widely varying characteristics. It is therefore recommended that Jaguar approved tyres are fitted to all wheels.

All Jaguar approved tyres have a letter 'J' marked on the sidewall.

Do not interchange tyres from side to side, front to rear or vice versa as tyre wear produces characteristic patterns depending upon their position and, if the position is changed after wear has occurred, the performance of the tyre will be adversely affected.

A tyre recommendation placard is placed on the inside of the fuel filler flap, giving information specific to the vehicle's wheel and tyre equipment.

Always ensure that the wheel nuts are fully seated before finally tightening the nuts in alternate sequence.

Tyre renewal

When renewal of tyres is necessary it is preferable to fit a complete vehicle set. Should either front or rear tyres only show need for renewal, new tyres must be fitted, as axle sets, to replace worn ones.

Note: After new tyres have been fitted the wheels need to be dynamically balanced.

The radial ply tyres specified are designed to meet the high-speed performance capability of this vehicle.

Do not fit tyres with a different tread pattern, size or speed rating.

Tyre pressures

The tyre pressures recommended (see Section 8) provide optimum ride and handling characteristics for all normal operating conditions. The pressures should be checked, and correctly set, if necessary, once per week. This should be done with the tyres cold. Tyre temperatures and pressures increase when running.

Deflating a warm tyre to the recommended pressure will result in under-inflation which may be dangerous.

A slight natural pressure loss occurs with time. If this exceeds 2 lbf/in² (0,14bar/14kPa, 0,14kg/cm²) per week, the cause should be investigated and rectified.

It is an offence in certain countries to drive a vehicle with tyres that are not inflated in accordance with the vehicle's proper use.

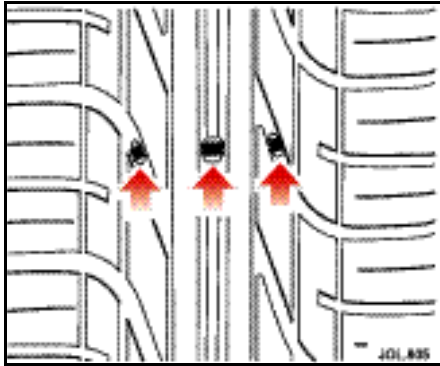

Wear

All tyres fitted as original equipment include tread wear indicators (TWI) in their tread pattern. When the tread has worn to a remaining depth of 1,6mm the indicators appear at the surface as bars which connect the tread pattern across the full width of the tyre.

It is illegal, in certain countries, to continue to use tyres after the tread has worn to less than 1,6mm over three quarters of the width and the entire circumference of the tyre.

It should be noted that the properties of many tyres alter progressively with wear. In particular the 'wet grip' and aquaplaning resistance are gradually but substantially reduced. Extra care and speed restriction should therefore be exercised on wet roads as the effective tread depth diminishes.

Incorrect wheel alignment will accelerate tyre wear. Fins on the inner or outer edges of the tread pattern are caused by excessive toe-in or toe-out respectively. As fins may also be caused by high cornering speeds or road camber, it is advantageous to have the cause detected by having the wheel alignment checked.

Tyre repair

It is recommended that damaged tyres are discarded and new tyres fitted. They must not be repaired in view of the high performance capability of the vehicle.

Damage

Excessive local distortion can cause the casing of a tyre to fracture and may lead to premature failure. Tyres should be examined especially for cracked walls, exposed cords, etc. Flints and other sharp objects must be removed from the tyre tread; if left in they may work through the cover. Clean off any oil or grease contamination by using a suitable cleaner.

Caution: Do not use paraffin (kerosene), because this has a detrimental effect on rubber.

Tyre use after vehicle storage

After a long period of a vehicle standing, tyres may become locally distorted with a flat area. This will cause an uneven ride for a few miles until the tyres have warmed up and the 'flat' rounds off.

However, to reduce the effects of flat-spots, the tyres of a stored vehicle may be inflated to pressures not exceeding 50 lbf/in² (3,4 bar, 343 kPa).

7-20 Maintenance

Winter (snow) tyres

The tyres fitted as original equipment are designed with a rubber compound, tread pattern and width specially suited for high speeds in normal road conditions, but they are less suitable during extremes of low temperatures, snow and ice. The use of winter tyres will considerably improve the vehicle's handling during these conditions.

It is recommended that only Jaguar approved winter tyres are used, as follows:

Pirelli205/55R16

or

Continental205/55R16

or

Pirelli225/45R17

Tyre directional indicators must be rotating in a clockwise direction when viewed from the right-hand side of the vehicle, and anti-clockwise when viewed from the left-hand side of the vehicle.

Do not exceed 130 mph (210km/h) when using Jaguar approved winter tyres.

Winter tyres must be used in vehicle sets, that is, fitted on all four wheels.

Tyres other than those recommended must be inflated to the following cold inflation pressure (front and rear):

44 lbf/in² (3,0bar, 3,1kg/cm², 300KPa).

In the event of using non-Jaguar approved winter tyres, inflate to the above recommended tyre pressure and do not exceed the tyre's speed capability.

Snow chains

Snow chains, of the recommended type, may only be fitted to 16inch front wheels.

Caution: Snow chains must not be fitted to 17inch wheels.

Contact your Jaguar Dealer for details and availability of approved snow chains.

The maximum speed when using snow chains is 30 mph (48km/h).

Remove the snow chains immediately the roads are clear of snow.

Ensure the fitting instructions supplied with the snow chains are kept in a safe place, for example, with this literature pack.

Note: Dynamic Stability Control **MUST** be switched **OFF** when using snow chains.

Vehicle care

Valet kit

A valet kit containing a selection of Car Care products is available from the Jaguar accessory range.

Interior care

Brush and clean the interior regularly. Use a vacuum cleaner where possible to remove all dust from the interior and trim.

Carpets

Marks or stains can be removed by gentle scrubbing with a weak solution of soap and warm water.

For more stubborn stains a commercially available carpet cleaner should be used. See your Jaguar Dealer for advice.

Headlining

Remove dust in the headlining with a vacuum cleaner. To remove stains, dab gently without pressing, using a fluff-free white cloth, moistened with Jaguar Upholstery Cleaner.

Do not use methylated spirit or solvents as this may cause damage or discoloration to the headlining.

Leather upholstery

Dust and dirt can penetrate the pores and creases of leather, causing surface wear and brittleness.

Use only mild non-caustic soap.

Clean regularly, every two to three months, with natural materials to maintain the leather in first class condition.

Wipe the surfaces using a cloth which has been dampened with warm soapy water and then wrung out; avoid over-wetting. Dry off and rub with a clean soft cloth, changing surfaces regularly. Use Jaguar Leather Cleaner for heavily soiled areas.

Note: Do not use solvents such as petrol (gasoline), white spirit or alcohol. Do not use detergents, furniture polish or household cleaners. Although such treatments may give, initially, an impressive appearance, their use will lead to rapid damage or deterioration of the leather, and will not be covered by the Manufacturer's Warranty. Unless spillages of tea, coffee or ink are washed away immediately, permanent staining may have to be accepted.

If a valeting service is used, ensure that the specialist firm concerned are aware of, and follow these instructions precisely.

Cloth upholstery

Weekly light vacuuming can extend the life of the fabric.

Using Jaguar Upholstery Cleaner, following the instructions, will preserve and enhance cloth upholstery. Test the upholstery cleaner solution on an unseen part of the seat. Do not over wet.

Caution:

- 1. Never use soap, ammonia, bleach or other cleaners intended for use on hard surfaces.**
- 2. Do not use upholstery cleaner on electrical equipment such as fascia switches.**

Removing stains

Most stains on woollen fabric can be removed if treatment is carried out immediately, before the stain has a chance to 'dry-in'.

Keep the necessary cleaning materials in a convenient place.

Most stains can be treated with one of three cleaning fluids: Jaguar Upholstery Cleaner, dry cleaning fluid or clean water.

7-22 Maintenance

Mop up excess liquid with absorbent tissue (preferably white) or absorbent cloth; scoop up dry solids. Work inwards from the edge of the stain to prevent spreading. Use small amounts of cleaning liquid, blotting between applications.

Work slowly and thoroughly using light pressure. If the stain cannot be removed, contact a reputable dry cleaners.



WARNING:

Dry Cleaning Fluids may be toxic or flammable. Take adequate precautions when handling these products.

Exterior care

Note: All the cleaning materials mentioned in this section are available from the Jaguar Accessory Range.

Washing

For best results, do not wash the vehicle under strong sunlight. Always allow the vehicle to cool down before washing.

Do not use a dry cloth to wipe dirty paintwork. Dust and gritty substances are abrasive and will scratch the paintwork. Remove dirt using a cellulose sponge and plenty of warm (never hot) water. Rinse off with clean water and dry using a clean, damp chamois leather.

Do not use household soaps or detergents. The use of Jaguar Vehicle Shampoo is recommended.

Do not direct hoses at full force around door and luggage compartment seals. Using high pressure water jets on the paintwork is not recommended.

Do not allow bird droppings or tree sap to harden. Remove from paintwork immediately with a lukewarm soap and water solution.

In winter, when salt is used on the roads, wash the vehicle frequently, and immediately after encountering such conditions. Clean undersides and wheel arches using a high pressure jet.

Automatic car wash

Note: Regular use of automatic car washes tends to dull the lustre of the paintwork.

After leaving the car wash, switch on the windscreen wiper immediately to remove water and prevent a build up of wax. Jaguar Screen Clean Paste can be used to clean any residual wax from the glass.

Removing grease or tar

Remove grease or tar with Jaguar Tar Remover or methylated spirit (alcohol). White spirit is also effective, but must not be applied to rubber, particularly the windscreen wiper blade.

Glass surfaces

To avoid scratching glass surfaces, do not clean dirty glass with dry paper or cloth. Use clean, warm water and a chamois leather which is reserved for glass only.

The following products will ensure glass surfaces and windscreen wipers are kept in good condition:

Jaguar Screen Clean Paste– Apply to the exterior of the windscreen only to ensure effective operation of the windscreen wiper.

Jaguar Glass Cleaner– Interior and exterior of all other glass surfaces.

Jaguar Screen Wash– Washer reservoir additive.

Jaguar Winter Care Kit comprising de-icer, ice scraper, anti-mist wipe cloth and aerial cleaner– for use in adverse weather conditions.

Note:

1. Renew the wiper blades when worn to prevent scratching. Clean the rubber wiper blades regularly with a mild detergent solution.
2. It is advisable to clean the windscreen with Jaguar Screen Clean Paste at regular intervals.

Cleaning the rear screen

To avoid damaging the heating and radio elements when cleaning the inside of the rear screen use only a soft damp cloth or chamois leather. Do not use solvents or sharp objects to clean the glass.

Polishing paintwork and chromium plating

For maximum protection against road dust, salts, industrial fall-out etc., it is recommended that the vehicle is polished regularly using Jaguar Polish, Chrome Polish and a Polishing Cloth.

Paint chips

Scratches and chips should be touched in before weathering action begins. Inspect the paintwork immediately after the vehicle has been washed.

Underbonnet cleaning

Underbonnet cleaning using high pressure hoses or steam cleaners should be done by a Jaguar Dealer. Indiscriminate use of cleaning equipment could damage or contaminate the electronic control modules and fuse boxes.

Care of alloy road wheels

The alloy road wheels are covered with a protective anti-corrosion coating. To prevent corrosion it is essential that this coating is not damaged.

When removing or fitting tyres always advise the tyre fitter to treat the alloy wheels with great care and to only use equipment with spigot or stud hole clamping. The equipment must not have any moving parts which contact the wheel, and tyre levers must not be used.

Wash the wheels with soap and water at two week intervals to avoid an accumulation of particles which could become embedded in the wheel surface. In salty conditions the wheels should be cleaned weekly.

In compliance with German Road Traffic Law the size of the wheel rims is stamped or cast on all wheels.

Electrical accessories



WARNING:

Alterations to the electrical system, including the fitting of accessories not designed for this Jaguar, will cause damage to the electrical circuits and systems. In some circumstances this could result in a malfunction or fire. All accessory work should be entrusted to a Jaguar Dealer.

The cigar lighter sockets can be used for plug-in accessories which are only temporarily connected to the vehicle (for example, a car vacuum cleaner).

Caution:

- 1. Under no circumstances must the power supply be obtained directly from either battery terminal.**
- 2. The use of non-approved accessories can reduce the battery capacity and charge period to an unacceptable level, therefore, Jaguar cannot accept any liability for the fitment of any such item.**

Earth points

If an accessory needs to be connected to an earth point, consult a Jaguar Dealer.

Caution: Under no circumstances must holes be drilled in the bodywork to accept earth terminals.

Vehicle data

Engine	2.5 Litre	3.0 litre
Type	V6, dual overhead camshafts, 4 valves/cylinder	V6, dual overhead camshafts, 4 valves/cylinder
Capacity	2495 cm ³ (152 inch ³)	2967 cm ³ (181 inch ³)
Bore	81.6 mm (3.212 inch)	89 mm (3.504 inch)
Stroke	79.5 mm (3.130 inch)	79.5 mm (3.130 inch)
Compression ratio	10.5:1	10.5:1

8-2 Specifications

Weights (average/approximate)

Gross combination weight is the gross vehicle weight plus recommended trailer weight.

	Vehicles with automatic transmission		Vehicles with manual transmission	
	lbs	kg	lbs	kg
Kerb weight, no options fitted	3516	1595	3428	1555
Front axle kerb weight	2138	970	2061	935
Rear axle kerb weight	1378	625	1366	620
Unladen weight, including 90% fuel and 75 kg driver . . .	3670	1665	3582	1625
Gross vehicle weight(G.V.W.)	4574	2075	4486	2035
Gross front axle weight	2418	1097	2352	1067
Gross rear axle weight	2156	978	2134	968
Gross combination weight	7881	3575	7793	3535

Roof-rack capacity and trailer weights

	lbs	kg
Roof-rack capacity including weight of rack	176	80
Maximum permitted luggage compartment load with four passengers and driver	132	60
Trailer weight:		
Braked	3306	1500
Unbraked (maximum recommended)	1653	750
Trailer nose load.	132	60

Note: loads greater than 132 lbs (60kg) may be carried in the luggage compartment provided the maximum permissible axle weights shown on the Vehicle Identification Plate are not exceeded and that tyres are inflated to the ‘normal pressures’.

8-4 Specifications

Dimensions

	inch	mm
Overall length	183.9	4672
Overall width including mirrors	78.8	2003
Overall width without mirrors	70.1	1782
Overall height (at gross vehicle weight)	54.8	1392
Wheelbase	106.7	2710
Track:		
Front	59.9	1522
Rear	60.5	1537

Wheels and tyres

Wheel size/type	Tyre size/manufacturer
6.5" x 16" 5 Spoke Alloy	205/55R16 91V Pirelli P6000 Powergy
6.5" x 16" 10 Spoke Alloy	
7.0" x 17" Double5 Spoke Alloy	225/45R17 91W Pirelli P Zero or 225/45R 17 91V Continental ContiSportContact
6.5" x 16" Steel	205/55R16 91V Pirelli
4" x 16" Steel	T125/85R16 99 M Pirelli (Temporary-use spare wheel)

Tyre pressures (These tyre pressures apply to Jaguar recommended tyres only)		
	Comfort (Speeds below 160km/h)	Normal (Speeds above 160km/h)
Front	30lbf/in ² (210kPa, 2,1bar, 2,1kg/cm ²)	38lbf/in ² (260kPa, 2,6bar, 2,6kg/cm ²)
Rear	30lbf/in ² (210kPa, 2,1bar, 2,1kg/cm ²)	35lbf/in ² (240kPa, 2,4bar, 2,4kg/cm ²)
Temporary-use sparewheel	60lbf/in ² (410kPa, 4,1bar, 4,2kg/cm ²)	

8-6 Specifications

Tow-bar fixing points

The rear longitudinal members are factory pre-marked (A) for drilling for tow-bar mountings.

Tow-ball centre height from the ground at Gross Vehicle Weight (GVW):

(B) = 385 mm

Tow-ball centre distance from bumper cover:

(C) = 76 mm

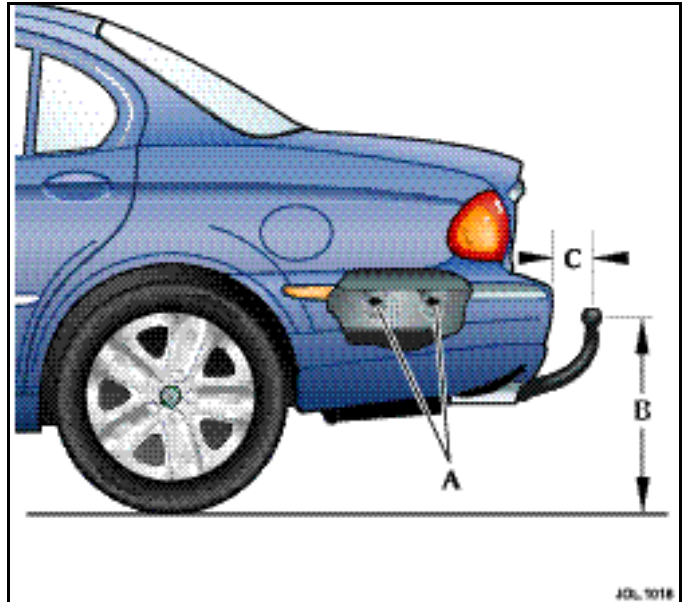

Airbags	3-4	– high mounted stop light	6-15
Alarms and audible signals	2-9	– number plate light	6-14
– audible signals	2-9	– parking (side) light	6-14
– error signals	2-9	– rear light assembly	6-15
– full alarm	2-9	Capacities	7-13
Alloy wheels – care of	7-23	Carpets	7-21
Alternator	7-14	Catalytic converters	4-47
Anti-freeze	7-12	Checks and replenishment	
Anti-lock braking system (ABS)	4-38	– brake/clutch fluid	7-9
Armrest	4-28	– engine coolant	7-11
Audible warnings	4-8	– engine oil	7-6
Auto headlights	4-19	– power steering fluid	7-8
Automatic car wash	7-22	– washer fluid	7-10
Automatic climate control with LCD screen	5-7	Child restraint tether anchorages	3-11
Automatic climate control with touch screen	5-11	Child safety	3-10
Automatic transmission	4-35	– door locks	2-7
Auto-relocking	2-8	Cigar lighter and ashtray	4-30
Battery	7-14	Climate control	5-1
– charging	7-15	Clock adjustment	1-8
– electrolyte level – check/replenish	7-15	Cloth upholstery – cleaning	7-21
– lead connection/disconnection	7-16	Coolant level – check/replenish	7-11
Bonnet release	7-3	Cruise (speed) control	4-16
Brake/clutch fluid level check	7-9	Cupholder	4-28
Brakes	4-38	Daylight running lights	4-19
Bulb renewal	6-12	Dimensions – vehicle	8-4
– front direction indicator	6-14	Dimmer switch	4-23
– front fog light	6-14	Direction indicators	4-21
– headlight, dip beam	6-13	Door guard/puddle lamps	4-22
– headlight, main beam	6-12	Door locks and handles	2-4

Index

- Door mirrors
 - adjustment 3-17
 - power fold back 3-18
- Door window operation 3-16
- Drive-away door locking 2-7
- Dynamic stability control 4-40

- Earth points 7-24
- Electrical accessories 7-24
- Emergency starting 6-2
- Engine
 - anti-freeze 7-12
 - block heater 7-12
 - coolant level check 7-11
 - data 8-1
 - oil level check 7-6
 - temperature 4-2
- Exterior care 7-22
- Exterior lighting 4-18

- Fire extinguisher 4-43
- First aid kit 4-43
- Foreign travel 4-43
- Fuel and refuelling 4-45
 - catalytic converters 4-47
 - level gauge 4-1
 - requirements 4-46
 - tank capacity 7-13
 - tank filling 4-45
 - unleaded 4-46
- Fuse box
 - engine compartment 6-18
 - locations 6-17
 - passenger compartment 6-18
- Fuse replacement 6-17
- Fuses and fuse boxes 6-16

- Gear-shift interlock 2-1
- General driving information 4-41
- General information 1-1
- General maintenance 7-1
- Glass surfaces – cleaning 7-22
- Glove compartment 4-31
- Grease or tar removal 7-22

- Handbrake 4-27
- Hazard warning 4-21
- Head restraint adjustment 3-14
- Headlight levelling 4-20
- Headlight powerwash 4-26
- Headlining – cleaning 7-21
- Health and safety 1-3
- Horn 4-27

- Ignition switch 2-1
- Illuminated entry/exit 4-22
- Inclination (tilt) sensing 2-10
- Inertia switch 6-1
- Infant safety 3-11
- Instruments 4-1
 - engine temperature 4-2

-
- fuel level gauge 4-1
 - odometer 4-1
 - speedometer 4-1
 - tachometer 4-1
 - Interior care 7-21
 - Interior features 4-28
 - Interior lighting 4-21
 - Interior rear view mirror 3-19
 - Internal door locking and unlocking 2-6
 - Intrusion sensing 2-10

 - Jacking 6-4
 - Jaguar
 - Dealers 1-1
 - diagnostic system 1-4
 - parts and accessories 1-1
 - Jaguar Assist system
 - message list 1-13

 - Key transmitter 2-3
 - battery renewal 2-4
 - care of 2-3
 - Keys 2-2

 - Leather upholstery – cleaning 7-21
 - Light switch – exterior lights 4-18
 - Light-weight luggage hook 4-31
 - Limp home mode 4-36
 - Locking and unlocking
 - auto-relocking 2-8
 - child safety locks 2-7
 - double-locking 2-7
 - drive-away door locking 2-7
 - luggage compartment 2-8
 - vehicle 2-5
 - Locking wheel nuts 6-5
 - Luggage
 - tie-down loops 3-21
 - Luggage compartment 3-20

 - Maintenance
 - general precautions 7-1
 - regular checks 7-4
 - reservoir and dipstick locations 7-5
 - Manual climate control 5-4
 - Manual transmission 4-37
 - Message centre 4-9
 - clearing messages 4-15
 - illumination 4-9
 - language selection 4-14
 - messages 4-10
 - Mirror
 - heating 3-17
 - interior 3-19
 - power fold back 3-18
 - Mobile/portable phones 1-5

 - Occupant protection 3-1
 - Oil specification 7-7

Index

- Paint – polishing 7-23
- Paint chips 7-23
- Panic alarm 2-10
- Power steering fluid level check 7-8
- Powerwash system fluid level check 7-10
- Protect the environment 1-4

- Radio frequency approval 2-11, 2-12
- Rain sensitive wiper control 4-25
- Rear centre armrest 4-30
- Rear seatback fold down 3-20
- Rear sun blind 4-32
- Recommended engine oil 7-7
- Regular checks and replenishment 7-4
 - brake/clutch fluid 7-9
 - engine coolant 7-11
 - engine oil 7-6
 - power steering fluid 7-8
 - windscreen washer fluid 7-10
- Regular servicing 1-4
- Reservoir and dipstick locations 7-5
- Reverse park control 4-23
- Roadside emergency 6-1
- Roof-rack 4-43
 - capacity 8-3

- Seat adjustment 3-12
- Seat belt
 - fitting 3-1

- inertia reel mechanism check 3-2
- Security
 - to lock the vehicle and set the alarm 2-5
 - to unlock and disarm the vehicle 2-5
- Sliding armrest 4-29
- Snow chains 7-20
- Specifications 8-1
- Speedometer 4-1
- Sport mode 4-37
- Starting/stopping the vehicle 4-33
- Steam cleaning – underbonnet area 7-23
- Steering column adjustment 3-15
- Steering column lock 2-1
- Sun visors 4-30
- Sunroof 4-24

- Tachometer 4-1
- Temporary-use spare wheel 6-5
- Touch screen display 1-6
- Touring 4-43
- Touring headlight adjustment 4-20
- Tow-bar fixing points 8-6
- Towing a caravan or trailer 4-44
- Towing eye 6-11
- Traction control 4-40
- Trailer weights 8-3
- Trip computer 4-13
- Tyre pressures 8-5
- Tyre size 8-5
- Tyres 7-18
 - damage 7-19

– pressures	7-18	Warning triangle	4-43
– renewal	7-18	Washing, vehicle	7-22
– repair	7-19	Weights	8-2
– snow chains	7-20	Wheel changing and jacking	6-4
– wear	7-19	Wheel size/type	8-5
– winter	7-20	Window	
		– anti-trap feature	3-17
Underbonnet cleaning	7-23	– operation	3-16
Used engine oil	7-2	Windscreen	
		– cleaning	7-22
Vanity mirrors	4-30	– washer/powerwash fluid – check/replenish	7-10
Vehicle		– wipers/washers	4-25
– care	7-21	– wipers/washers – maintenance	7-17
– data	8-1	Winter driving	4-42
– dimensions	8-4	Winter tyres	7-20
– engine number	1-4	Wipers and washers – operation	4-25
– global closing	2-6		
– identification	1-4		
– locking/unlocking	2-5		
– recovery	6-9		
– security	2-2		
– security light	2-2		
– smart locking	2-5		
– transporting	6-10		
Vehicle identification	1-4		
Vehicle identification number (VIN)	1-4		
Warning and cautions	1-2		
Warning lights – instruments	4-2		
Warning symbols on the vehicle	1-2		

JJM 10 02 20/15