

Instruments

INSTRUMENT CLUSTER

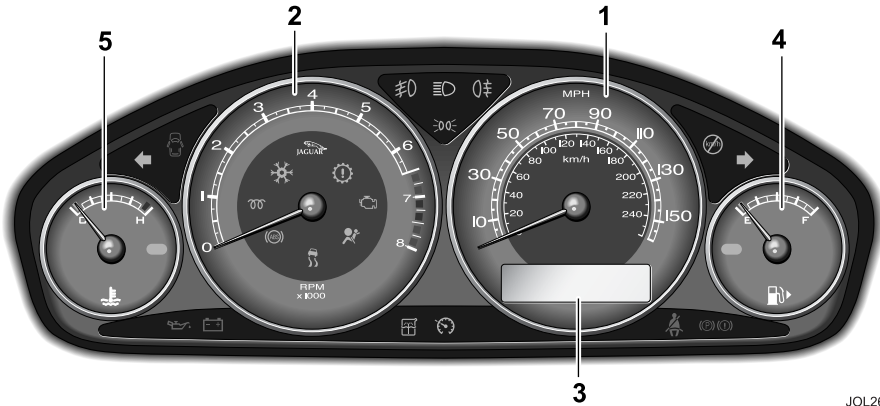

JOL2618

None of the instruments will show correct indications until the ignition is switched ON (position II).

1. Speedometer.
2. Tachometer.
3. Odometer.
4. Fuel gauge.
5. Temperature gauge.

SPEEDOMETER

Speed indication is in either:

- miles per hour, the outer figures, and kilometres per hour or;
- kilometres per hour, the outer figures, and miles per hour or;
- kilometres per hour only.

TACHOMETER

The tachometer indicates engine speed in revolutions per minute and is calibrated in increments of 250.

- For petrol models, the scale extends to 8000 rev/min.
- For diesel models, the scale extends to 5000 rev/min.

Caution: Do not allow the needle to enter the red sector.

FUEL LEVEL GAUGE

Indicates the amount of fuel in the tank. The amber warning light illuminates as a low fuel reminder.

The small arrow, shown beside the fuel pump symbol, identifies on which side of the vehicle the filler cap is located.

Instruments

ODOMETER

Records the total distance covered by the vehicle.

The odometer reading is displayed below the speedometer, along with the trip distance since it was last reset. To reset the trip distance, press and hold the mode button on the end of the left column stalk switch for 3 to 4 seconds. The trip distance will roll-over at 999.9 kilometres (or 999.9 miles).

If the vehicle has a message centre then the odometer is displayed in the message centre unless a message has priority or a trip computer function has been selected. The trip distance will roll-over at 16,090 kilometres (9999.9 miles).

ENGINE TEMPERATURE

Drive at moderate road and engine speeds until normal operating temperature is reached. This is indicated when the pointer is between the blue (cold) segment and the red (hot) segment.

The engine operating temperature will vary with changes in weather and engine load. The engine temperature may rise in some circumstances, such as:

- Idling for long periods in slow moving traffic.
- Driving up a long hill in hot weather.
- Driving slowly or stopping after driving at high speed.
- Towing a trailer or caravan.

Should the pointer move into the red segment (**H**) or the red light illuminate, stop the vehicle as soon as it is safely possible, turn off the engine and open the bonnet to allow the engine to cool.



WARNING:

The radiator cooling fans may continue to run after the ignition has been switched off but will automatically switch off when the engine has cooled sufficiently.

Warning Lights

GENERAL DESCRIPTION

Warning lights are arranged within the instrument cluster.

When a message centre is fitted there are two warning lights, one red, the other amber, located above the message centre for primary and secondary status of the warnings displayed by the message centre.

RED warning lights are for primary warnings. A primary warning must be investigated immediately by the driver or a Jaguar Dealer/Authorised Repairer.

AMBER warning lights are for secondary warnings when the driver must take action and then report the fault to a Jaguar Dealer/Authorised Repairer at the earliest opportunity.

Other lights indicate system status, such as blue for main beam and green for direction indicators, when in operation.

A light check is initiated when the ignition is switched ON and lasts for three seconds (except the airbag warning light, which will remain on for 6 seconds). If any warning light remains on after this period, investigate the cause before driving.

When activated, some warning lights have associated messages displayed on the message centre.

Note: *Not all lights are included in the light check, for example main beam headlights or direction indicators.*

High engine temperature (red)

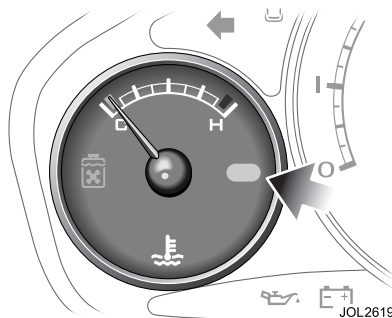

WARNING:

It is unsafe to run the engine in an overheated condition.

The first indication of high engine temperature will be the needle entering the RED zone of the coolant gauge and the illumination of the engine high temperature warning light.

If driving, pull to the side of the road and stop the engine when it is safe to do so. Allow the engine to cool.

To assist cooling, high engine temperature automatically turns off the air conditioning. To maintain some cooling it is advisable to switch the air distribution to recirculation.

If a message centre is fitted the light will illuminate and a message will be displayed.

Warning Lights



WARNING:

Do not remove the coolant reservoir filler cap while the engine is hot. If it is essential, then protect your hands against escaping steam. SLOWLY turn the cap anti-clockwise to allow the steam pressure to escape completely before removing the cap.

Low oil pressure (red)



This illuminates with the ignition switched ON and should be extinguished when the engine is running.

If the warning light stays ON when the engine is running, loss of oil pressure is indicated. STOP the engine immediately and investigate the cause.

Caution: Do not restart the engine until the cause of loss of oil pressure has been identified and rectified.

First check the engine oil level, see page 188.

Seat belt (red)



Illuminates when the ignition is ON and the driver's seat belt is not fastened. If the warning

light stays ON with the seat belt fastened, report the fault to a Jaguar Dealer/ Authorised Repairer. It is safe to drive the vehicle with the light ON, provided that the seat belt is properly fastened.

Ensure that all occupants' seat belts are fastened before driving.

Door ajar warning (red)



Illuminates if one or more doors or the luggage compartment lid are open.

If a message centre is fitted the light will not illuminate but instead a message will be displayed.

Charge indicator (red)



Illuminates when the ignition is ON and should be extinguished when the engine is running.

If the light stays ON when the engine is running it indicates that there is an alternator fault.

Turn OFF all electrical accessories, radio, climate control, rear screen heater etc. Try to use the minimum electrical load possible and avoid using power windows, electric sunroof etc.

Report the fault to a Jaguar Dealer/ Authorised Repairer.

Powertrain malfunction (red)



(Petrol only) Illuminates when there is an engine malfunction or transmission system malfunction.

If a message centre is fitted the light will not illuminate but instead a message will be displayed.

Warning Lights

Brake (red)

 This light illuminates when:

- The ignition is ON and the handbrake is applied.
- The brake fluid is low.
- There is a fault with the electronic brake system (with the ABS light illuminated).

If the light is ON with the handbrake NOT applied, low brake fluid or a fault with the electronic brake system is indicated. In this case, there may be a loss of braking assistance in one, or both, brake circuits. If the light is ON with the ABS light also ON then the electronic brake system may not function correctly, which can impair stability when the brakes are applied.



WARNING:

DO NOT drive the vehicle until the fault is rectified. Consult a Jaguar Dealer/ Authorised Repairer immediately.

Anti-lock braking system (ABS) (amber)

 If a fault has been detected in the anti-lock brake system (ABS) this light will illuminate.

The brake system will continue to function normally, but without ABS braking.

Should the light come on or stay on after the bulb check cycle, stop the vehicle at the first opportunity, turn the engine OFF and then restart.

If the ABS light comes on again, the vehicle should be driven to a Jaguar Dealer/Authorised Repairer at the earliest opportunity.

Traction control/DSC (amber)



The light will flash at the rate of twice a second when traction control/DSC is operating.

The light is ON continuously when a fault is detected in the system or the system is turned OFF.

If a message centre is fitted the light will not illuminate but instead a message will be displayed.

Engine malfunction (amber)



This light illuminates when there is an engine malfunction.

Specialised diagnostic equipment is required to repair such faults. Report the fault to a Jaguar Dealer/ Authorised Repairer.

The vehicle may go to limp home mode, with the possibility of reduced engine performance. Drive the vehicle with caution.

Side (parking) lights (green)



Illuminates when the side (parking) lights are switched ON.

Cruise (speed) control activated (green)



Illuminates when cruise control, if fitted, is ENGAGED.

If a message centre is fitted the light will not illuminate but instead a message will be displayed.

Airbag (amber)



If the airbag system develops a fault, the warning light will flash and then come ON and remain on until the fault has been diagnosed and cleared.

Warning Lights

Report the fault to a Jaguar Dealer/ Authorised Repairer immediately.

It is safe to drive the vehicle; however, in an accident the airbags may not operate.

Main beam (blue)



Illuminates when the main beam headlights are switched ON or flashed ON.

Front fog lights (green)



Illuminates when the front fog lights are switched ON.

Rear fog lights (amber)



Illuminates when the rear fog lights are switched ON.

Direction indicators (green)



The appropriate indicator tell-tale will flash when the column

switch is moved up or down to signal a right or left-hand turn. If a direction indicator fails, the tell-tale will flash at twice normal rate when that indicator is selected. Fit a new bulb immediately.

Note: If a bulb has failed, the audible ticking will sound at twice the normal rate.

Hazard warning lights

When the hazard warning is selected, both direction indicator tell-tales flash simultaneously.

Low washer fluid level (amber)



Illuminates when the washer fluid level is low.

If a message centre is fitted the light will not illuminate but instead a message will be displayed.

Low fuel reminder (amber)

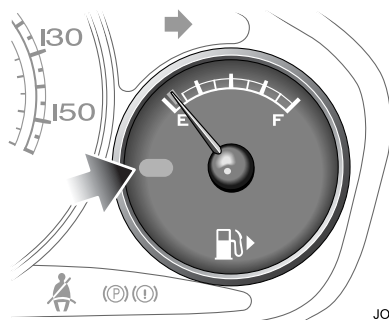

An amber lozenge in the fuel gauge illuminates when the remaining fuel has fallen to approximately 8 litres (1.75 gallons) including the reserve.

Note: Vehicles with diesel engines are equipped with a system to prevent the fuel tank from emptying completely. Refer to page 145.

Overspeed warning (red)



(Middle East countries only)
Illuminates if the vehicle speed exceeds 120 km/h (75 mph).

Warning Lights

Glow plugs (amber)



(Diesel only) Illuminates when the ignition is switched ON and switches off as soon as the glow plugs reach their operating temperature, indicating that the engine may be started.

Also acts as an Engine Malfunction lamp - it flashes in some error circumstances.

For more information on starting a diesel engine, refer to page 126.

Low outside temperature (amber)



(Where fitted). Illuminates when frost or ice is likely to form on road surfaces.

The light will continue to be illuminated until the outside temperature rises to a safer level.



WARNING:

Even if the light is not illuminated, there is no guarantee that at low temperatures the road is free from ice.

If required, the low outside temperature warning light can be disabled by a Jaguar Dealer/Authorised Repairer.

Audible Warnings

WARNING SOUNDS

Various sounds are produced for warning and notification purposes as follows:

Hazard or Condition	Remedy/chime or tone
External lights remain ON when the driver's door is opened.	A chime will sound until the lights are switched OFF or driver's door is closed. Note: <i>The chime will not sound if the switch is in the Auto position.</i>
Hazard warning indicators ON.	A ticking will sound until the hazard indicators are switched OFF.
Left or right direction indicators ON.	If the switch has not turned itself OFF, switch the turn indicator OFF when the manoeuvre is completed. A ticking will sound until the indicators are switched OFF.
Entry delay warning.	A ticking warning will sound. Disarm the alarm system within 15 seconds by placing a key in the ignition switch and turning to position I or press the key transmitter unlock button.
Airbag system failure.	A tone sequence is repeated five times. Report the fault to a Jaguar Dealer/Authorised Repairer as soon as possible.
Seat belt reminder (Middle East countries and Japan only).	A chime will sound until the driver's seat belt is fastened or the ignition switch turned to 0.
Automatic gear selector lever not in Park (P).	When the ignition key is turned from position II to position I a chime will sound for 10 seconds or until the lever is moved to Park.
Key in ignition warning.	A ticking will sound until either the key is removed, the driver's door is closed or the ignition switched ON.

Message Centre

MESSAGE CENTRE LOCATION

(Where fitted)

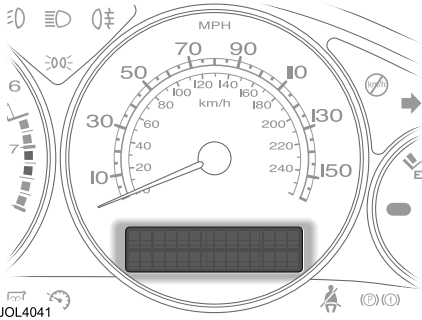

Driver information, messages and data are displayed on the message centre display panel situated within the instrument cluster.

For the message centre to operate the ignition must be switched ON (position II).

The message centre displays:

- The total distance covered by the vehicle.
- Trip computer information.
- Warning messages if system faults are detected.
- Status messages to indicate changes in state of certain vehicle functions.

MESSAGES



WARNING:

If a red warning light is displayed, stop the vehicle as soon as possible but only when it is safe to do so.

The primary function of the message centre is to inform the driver of the following:

- Warning messages.
- Temporary alert messages.
- Information messages.

Most messages, when displayed, have an associated warning light, red or amber, above the display which will come on to indicate the message priority.

If more than one message is active, each is displayed in turn for two seconds in order of priority.

Note: Messages take priority over the odometer reading or trip computer data and, if active, will be displayed when the ignition is switched ON.

Message centre illumination

The message centre is lit at all times when the ignition is ON.

All information displayed will be brightly lit if the exterior light switch is OFF.

If the exterior light switch is ON the display brightness can be varied using the dimmer switch.

Note: Warning lights and warning messages are always brightly lit and are not affected by the dimmer switch.

Message Centre

Message descriptions

The following tables list all messages and warning lights and explain their meaning.

Message	Warning Light	Priority Indicator	Meaning
LOW BRAKE FLUID LEVEL	Brake	Red	Displayed when the brake fluid level is low. Complete loss of braking may occur.
HIGH ENGINE TEMPERATURE	Engine Overtemp	Red	Displayed when engine temperature becomes excessive. Pull off the road when safe to do so and allow the engine to cool.
RESTRICTED PERFORMANCE	None	Red	This will be displayed when the vehicle has possible loss of power or driveability. Report the fault to a Jaguar Dealer/ Authorised Repairer.
ENGINE SYSTEM FAULT	Malfunction Indicator light	Amber or Red	Displayed when the 2.5 litre or 3.0 litre engine has defaulted to limp-home mode. Report the fault to a Jaguar Dealer/Authorised Repairer at the earliest opportunity. This message will not appear in 2.0 litre petrol or diesel vehicles.
GEARBOX FAULT	None	Amber	It is likely that the driver will experience a degradation of gearbox operation.
TRACTION CONTROL FAULT	Traction Control	Amber	Displayed when a fault occurs in the traction control system.
TRACTION CONTROL ON or OFF	Traction Control	Amber (OFF only)	Displayed when the traction control system is switched ON or OFF. The warning light will FLASH when the traction control system is switched ON and operating. When the system is switched OFF, the warning light in the instrument cluster will be illuminated until the system is switched back ON.

Message Centre

Message	Warning Light	Priority Indicator	Meaning
DPF FULL SEE HANDBOOK (Diesel models only)	None	Red or Amber	Amber displayed when the Diesel Particle Filter (DPF) requires to be regenerated, carry out DPF regeneration, see page 144. If Red priority is indicated contact a Jaguar Dealer/ Authorised Repairer as soon as possible.
DSC FAULT	Stability Control	Amber	Displayed when a fault occurs in the stability control system.
DCS ON or DSC OFF	Stability Control	Amber	Displayed when the stability control system is switched ON or OFF. The warning light will FLASH when the stability control system is switched ON and operating. When the system is switched OFF, the warning light in the instrument cluster will be illuminated until the system is switched back ON.
DRIVER'S or PASSENGER'S FRONT OR REAR DOOR OPEN	Door Ajar Warning	Red	Check that all doors are closed before driving.
BOOT OPEN	Door Ajar Warning	Red	Check that the luggage compartment lid (or Estate tailgate and tailgate glass) is closed before driving.
LOW WASHER FLUID LEVEL	Low washer fluid level	Amber	Replenish the washer fluid at the earliest opportunity.
CRUISE NOT AVAILABLE	None	Amber	Displayed when a fault has occurred in the cruise control system.
CRUISE ENGAGED or CRUISE CANCELLED	None	None	Displayed when cruise control is ENGAGED or CANCELLED.

Message Centre

Message	Warning Light	Priority Indicator	Meaning
SECURITY FAILED	None	Red	Displayed when a fault is detected in the security immobiliser system. The alarm security light in the centre console will flash. It is possible that the engine will not start. Report the fault to the nearest Jaguar Dealer/Authorised Repairer.

Trip Computer

TRIP COMPUTER FUNCTIONS

The computer memory stores data for a journey or series of journeys until it is reset to zero.

The displayed information is for guidance only, as it can be affected by traffic, road and weather conditions.

Two independent memories are available (A and B) to allow two separate journeys to be recorded concurrently, for example, work usage and evening/weekend usage.

Trip distance, average fuel economy and average speed will be prefixed A or B depending on the current memory selected.

Press the TRIP button on the end of the left column stalk switch repeatedly to display the data in the following order:

- Odometer.
- Trip distance.
- Distance to empty.
- Average fuel economy.
- Average speed.
- Messages.

Odometer

The odometer shows the total vehicle distance travelled since the vehicle was new.

When the ignition is switched ON (position **II**) the display shows the odometer and trip distance readings.

The odometer reading is displayed in either miles or kilometres, depending on the units selected with the trip computer.

Trip distance (A/B)

Distance travelled since the last memory reset. The maximum trip reading is 16,090 kilometres (9999.9 miles). The computer will automatically reset to zero if this distance is exceeded.

Distance to empty

Predicted distance, miles or kilometres, that the vehicle should travel on the remaining fuel, assuming average fuel economy and fuel consumption stay constant.

Average fuel economy (A/B)

The average fuel consumption, litres per 100 kilometres or miles per gallon, based on the accumulated distance travelled and the accumulated fuel used.

Average speed (A/B)

The average speed since the last press of the reset button.

Trip Computer

TRIP COMPUTER SWITCHPACK



JOL2623

ML/km

Pressing the ML/km switch alternately displays data in metric or imperial units.

A/B

Selects either A or B trip memory. Select the required data using the column stalk TRIP button and then pressing A/B will show the A or B information for that data.

RESET

RESET resets the selected trip to zero.

Warning and Information messages have priority over trip data and, if active, will be displayed when the ignition is at position II.

Note: *If warning messages are hidden, the warning/fault still exists and requires investigation.*

Resetting the trip computer

At the start of the journey (or series of journeys) to be recorded, reset the computer memory to zero as follows:

1. Press the TRIP button on the end of the left column stalk switch to select a trip function. The computer will display either TRIP A: or TRIP B: data.
2. Press the A/B switch to select the trip (A or B) to be reset.
3. Press the RESET switch and hold for 3 seconds.

The display will read:

RESETTING

TRIP A (or B).

Then it will reset and display:

A: 0 (or B: 0)

or the new value.

Note: *All trip functions, for A or B depending on which was selected, will be reset.*

Display language

To change the display language, switch the ignition ON while pressing the ML/km switch. The trip computer will display the current language.

Press the ML/km switch repeatedly to cycle through the available languages. Once the correct language is selected, press the A/B switch. The new language will be selected after a delay of three seconds.

Note: *If you wish to exit the language selection function without changing the display language, you can either press the RESET switch, wait for 10 seconds or switch the ignition OFF.*

Trip Computer

Trip

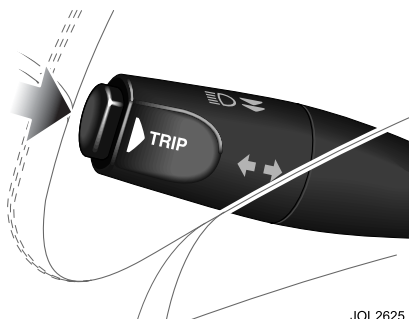

Press the TRIP button to cycle through: TRIP - ODOMETER - MESSAGES - CLOCK (where available).

Clock

If your vehicle is fitted with the Jaguar navigation system, the clock can be displayed in the message centre. Press the TRIP button on the end of the left column stalk switch to cycle through the trip functions and display the clock.

Note: *The time is adjusted via the touch-screen, refer to page 78 of this handbook.*

CLEARING MESSAGES

Messages can be hidden by pressing RESET on the trip computer switchpack. One press will hide one message. Once all messages have been hidden, the display will show trip data, a further press will display the odometer reading.

If RESET is pressed again, all active messages will be re-displayed. Repeatedly pressing the RESET button will cycle through the trip, odometer and message modes.

If a fault occurs when in trip computer or odometer mode, the relevant message will be displayed immediately.

If a trip computer function is selected by pressing the TRIP button while messages are displayed, the trip data will be displayed for 10 seconds, then the message will reappear.

Hidden messages reappear after an ignition OFF/ON cycle, if the fault remains.

Cruise (Speed) Control

CRUISE CONTROL SWITCHES

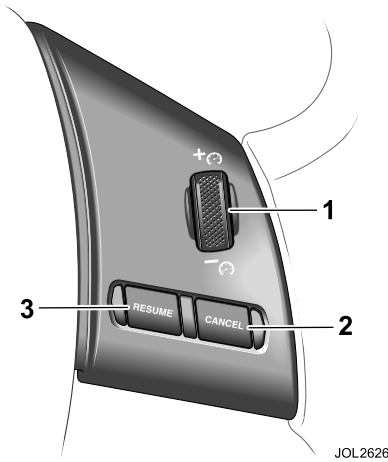

The cruise (speed) control system (where fitted) can be used by the driver to maintain a selected vehicle speed above 28 km/h (18 mph) for 2.5- and 3.0-litre vehicles, and 40 km/h (25 mph) for 2.0-litre petrol and diesel vehicles, without the driver having to use the accelerator.

Controls on the steering wheel allow the driver manual control of the system. Brake and clutch operations also influence the cruise control system.

1. SPEED ADJUSTMENT WHEEL is used to engage cruise control initially. It is also used to increase/decrease the set speed.
2. CANCEL cancels cruise control but retains the set speed in memory.
3. RESUME engages cruise control after it has been cancelled.

Setting vehicle speed



WARNING:

Only use cruise control when conditions are favourable, for example, straight, dry, open roads with light traffic.

When you are travelling at the speed you require, which must be above 28 km/h (18 mph) for 2.5- and 3.0-litre vehicles, and 40 km/h (25 mph) for 2.0-litre petrol and diesel vehicles, rotate the speed adjustment wheel towards + and then release it. Cruise control will engage and you can maintain the set speed and you can remove your foot from the accelerator pedal.



The instrument cluster light will illuminate to show that the system is on. Vehicles with a message centre will show the message CRUISE ENGAGED.

Note: Cruise control will automatically disengage when the brake pedal is pressed or when the vehicle speed falls below 28 km/h (18 mph) for 2.5- and 3.0-litre vehicles, and 40 km/h (25 mph) for 2.0-litre petrol and diesel vehicles. If the vehicle has a manual gearbox, pressing the clutch pedal will also disengage the cruise control. Vehicles with a message centre will show the message CRUISE CANCELLED.

Cruise (Speed) Control

Changing the set speed

To increase or decrease the set speed, rotate the speed adjustment wheel until the desired speed is obtained.

The speed adjustment wheel can be used in two ways:

- If the wheel is repeatedly rotated and released (i.e. flicked towards + or -), the set speed will increase/decrease in increments of 2 km/h or 1 mph.
- If the wheel is rotated towards + or - and held in position, the set speed will continuously increase/decrease.

Resuming the set speed

If the vehicle is accelerated above the set speed, then the set speed will be resumed when the accelerator pedal is released.

If CANCEL is pressed, or the brake or clutch pedal is pressed, the cruise control will disengage but the set speed memory will be retained. Press RESUME and the vehicle will return to the set speed.

Note: *Cruise control will not resume at speeds below 28 km/h (18 mph) for 2.5- and 3.0-litre vehicles, and 40 km/h (25 mph) for 2.0-litre petrol and diesel vehicles.*

Caution:

- **RESUME should only be used if the driver is aware of the set speed and intends to return to it.**
- **It is not recommended to resume set speed when a low gear is selected as excessive engine speeds will occur.**

Cruise control will switch off and clear the memory when:

- The ignition is switched to position 0.
- A fault occurs. The cruise control system will switch OFF and cannot be used until the fault is cleared.

Cruise control automatic switch off

Cruise control will switch off but the set speed will remain in the memory when:

- The CANCEL button is pressed.
- The brake pedal is pressed.
- The handbrake is applied.
- Speed falls below 28 km/h (18 mph) for 2.5 and 3.0-litre vehicles, and 40 km/h (25 mph) for 2.0-litre petrol and diesel vehicles.
- Neutral, Park or Reverse gear positions are selected.
- Traction control or DSC is operating.
- The difference between the actual and set speed is too great.
- When the vehicle reaches a maximum speed of:
Manual: 200 km/h (125 mph).
Auto: 192 km/h (120 mph).
- The accelerator pedal is used to accelerate beyond the set speed for too long a period.
- If the vehicle has a manual gearbox, pressing the clutch pedal will also disengage the cruise control.

Exterior Lighting

EXTERIOR LIGHTING SWITCH

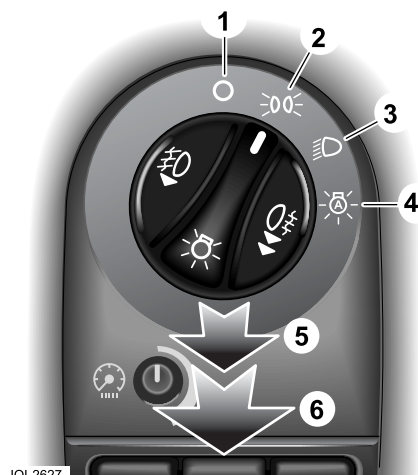

JOL2627

1. OFF.
2. Side (parking) lights.
3. Headlights.
4. Auto lights.
5. Front fog lights.
6. Rear fog lights.

The exterior lights are controlled by a rotary light switch mounted on the fascia and by the left-hand column switch.

The rotary switch has six positions. These are:

OFF (1) - All exterior lights OFF (except vehicles provided with daylight running lights).

Sidelights (2) - Switches ON front sidelights, tail, number plate and any other marker lights required by local legislation. When the external lights are ON the instruments will also be lit.

Headlights (3) - With the ignition in position **II**, this position switches on dipped headlights in addition to the lights switched on in position (2).

The left-hand column stalk switch has two pull positions. Pulling and releasing the switch to the first position causes the main beam to flash. The main beam can be flashed with the ignition in position **II** and will remain ON for as long as the switch is held.

The second position is to switch main beam headlights ON. With the ignition in position **II**, first select dipped beam lights (3), and then pull the column light switch, past the first position, fully towards the steering wheel.

The blue warning light on the instrument cluster and main beam headlights will come ON.

To turn main beam OFF, pull the column switch again to the main beam position.

Note: If dipped beam is switched OFF, with main beam still activated both dipped and main beam will be extinguished. Both dipped and main beam will illuminate if dipped is turned on again. The ignition must be in position **II** for the flash to operate.

Headlight convenience

The main beam lights are turned on for 30 seconds when the headlight convenience button on the key transmitter is pressed.

Note: The key must not be in the ignition switch for this feature to operate.

Exterior Lighting

The main beam lights can be turned off before the 30 second delay by pressing the headlight convenience button on the key transmitter or by turning the ignition to position **II**.

Auto lights (4) - A light sensor control (where fitted), mounted on the front of the interior mirror fixing cover, monitors exterior light levels and automatically switches the sidelights and dipped headlights ON or OFF.

The ignition switch must be in position **II** for automatic light operation.

When light fades to the non-adjustable, preset level, the sidelights and headlights will switch ON automatically.

As light increases to the preset level, the sidelights and headlights switch OFF automatically.

Do not cover the sensor and keep the windscreen clean. Obstructing the light in this area may lead to unwanted operation of the sidelights and headlights.

Front fog lights (5)

With the switch in sidelight or dip position, pull the switch to its first position to turn on the front fog lights. Pushing the switch in or turning it to OFF will turn off the front fog lights.

Note: *The front fog lights should only be used when visibility is severely restricted by fog.*

Front fog lights cannot be used with main beam headlights. If main beam headlights are switched on when the front fog lights are on, the front fog lights will be switched off.

The front fog lights will not turn on if they are selected when main beam headlights are on.

Rear fog lights (6)

With the switch in any position except OFF, pull the switch to its second position to turn on the rear fog lights. This will also turn on the front fog lights unless main beam is selected. Pushing the switch in or turning it to OFF will turn off the rear fog lights.

Daylight running lights

In certain countries it is a legal requirement for the lights to be on during the hours of daylight.

With the rotary light switch in the OFF position (**1**), dipped headlights, sidelights, tail, number plate lights and, where fitted, side marker lights will switch on automatically with the following conditions:

- The ignition is turned to position **II**.
- The vehicle gear selector out of park (automatic transmission only).
- The handbrake not applied (released).

Exterior Lighting

HEADLIGHT LEVELLING

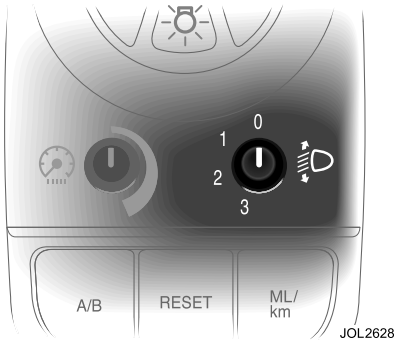

The headlight levelling switch operates when the headlights are switched ON. Push and release the knob to extend it for ease of operation. Push the knob again to place it in the stowed position.

Turn the knob to the setting appropriate for the vehicle load, for example:

- 0** Normal setting - Driver only.
- 1** Driver and one front passenger.
- 2** All seats occupied and maximum luggage.
- 3** Fully loaded vehicle and towing a caravan or trailer.

Auto headlight levelling

Automatic levelling of the High Intensity Discharge (HID) headlights is a feature which avoids dazzling oncoming drivers. A control unit adjusts the height of the lights during acceleration, deceleration and terrain variation.

TOURING HEADLIGHT ADJUSTMENT

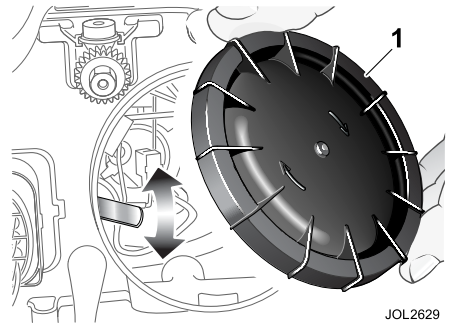

When touring in countries where you must drive on the opposite side of the road to your country, your vehicle dipped beam lights may dazzle oncoming drivers.

A lever, within the main beam headlight, is used for dipped beam adjustment for touring. This lever flattens the dipped beam to avoid dazzling oncoming drivers.

Open the bonnet and remove the round cover (1) from a main beam headlight.

Move the lever in the left-hand headlight down and move the lever in the right-hand headlight up, to flatten the beams for driving on the right side of the road.

Remember to place the levers back in their original positions when you return to your country of origin.

Exterior Lighting

HAZARD WARNING

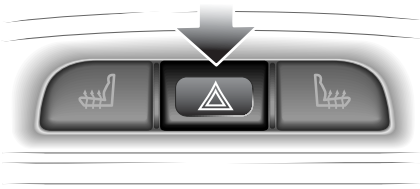

JOL2630

The switch is in the centre console and operates with the ignition ON or OFF. Use only in an emergency to warn traffic of a vehicle breakdown or approaching danger.

To operate: Press the switch; the direction indicators, the instrument cluster green indicators and audible warning will operate in unison.

To cancel: Press the switch again.

DIRECTION INDICATORS

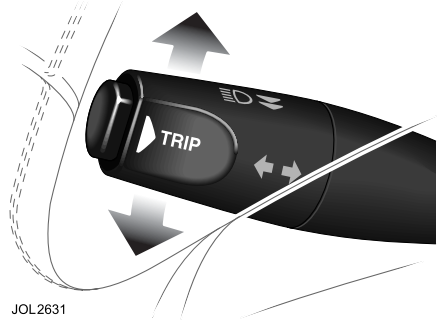

JOL2631

The direction indicators operate when the ignition is in position II. To indicate for a right or left turn, move the column left stalk switch up or down respectively. The switch will cancel when the turn is completed.

An audible ticking and a flashing green arrow on the instrument cluster indicates that the selected direction indicator is ON.

Should a direction indicator bulb fail, the corresponding side green warning light will flash at twice the normal rate. The audible ticking will sound at twice the normal rate.

Interior Lighting

READING/MAP LIGHTING

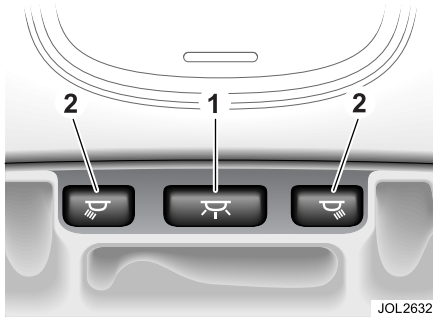

Interior lighting comprises, front and rear overhead courtesy lights, two front reading/map lights and a rear roof light. Vanity mirrors, glove compartment, footwell and luggage compartment lights are provided.

Press the centre switch (1) in the front roof console to turn the courtesy light on. A second press turns the light off.

The reading/map lights are turned on and off by individual switches (2).

ILLUMINATED ENTRY/EXIT

The courtesy lights will gradually illuminate and remain on for 25 seconds if:

- The vehicle is unlocked.
- The ignition switch is turned off (from position II to 0 or I).

If the courtesy lights are on they will fade off 25 seconds after the last door is closed, or when the vehicle is locked.

REAR ROOF LIGHT

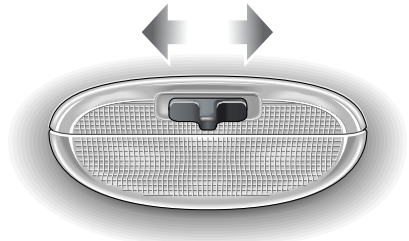

JOL2633

The rear roof light switch has three positions:

- In the left position the light will be switched on.
- In the centre position the light will come on or go off when a door is opened.
- In the right position the light will be switched off.

BATTERY SAVER

If the interior lights are switched on using the centre switch in the overhead console and the ignition switch is turned to positions 0 or I, the lights will automatically turn OFF after 30 minutes.

If the interior lights are switched on by opening a door and the ignition switch is in positions 0 or I, the lights will automatically turn off after 10 minutes.

If the glove compartment or vanity lights are switched on and the ignition switch is turned to positions 0 or I or the key is removed, the lights will automatically turn OFF after 30 minutes.

Interior Lighting

DIMMER SWITCH

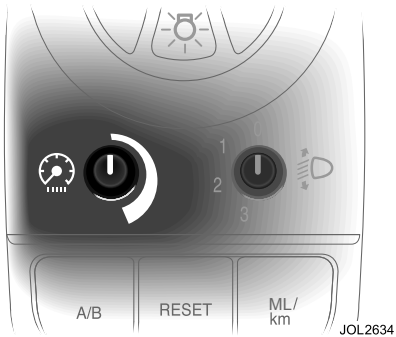

The instruments, door switch packs, in-car entertainment panel and the climate control panel will be lit when the ignition switch is in position **II**.

Push and release the knob to extend it for ease of operation.

Rotate the knob to adjust the illumination to the required level.

Push the knob again to place it in the stowed position.

Parking Assist

PARKING ASSIST SYSTEM

(Where fitted)



WARNING:

It remains the driver's responsibility to be vigilant when reversing. Small children or animals may not be detected by the system.

Caution: It remains the driver's responsibility to detect obstacles and estimate the car's distance from them. Some overhanging objects, barriers, thin obstructions or painted surfaces which could possibly cause damage to the vehicle may not be detected by the system. Always be vigilant when reversing.

Rear parking assist is switched on with the ignition. However, it only becomes active once reverse gear is selected.

Caution:

- If, for example, you are driving within a confined space such as a home garage, the outer sensors will detect the side walls and after 3 seconds will switch the tone off. However, as movement continues, the inner sensors will eventually detect the rear wall and will start the tone again.
- The rear sensors are not active when the gear selector is in neutral, therefore care should be taken if moving the vehicle as the tone will not sound.
- Do not clean the sensors with abrasive or sharp objects.

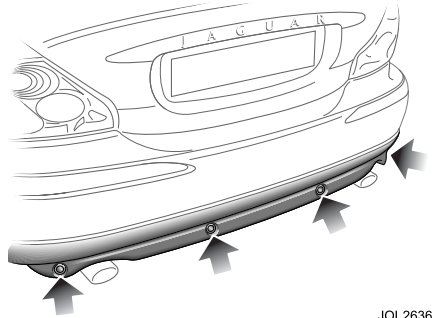

JOL2636

Note:

- For reliable operation, the sensors in the front and rear bumpers should be kept free from ice, frost and grime.
- When using a high pressure spray the sensors should only be sprayed briefly and not from a distance of less than 200 mm (8 inches). Do not clean the sensors with abrasive materials.

Towing

Where approved Jaguar tow-bar electrics are fitted, the reverse parking assist is automatically switched off if a caravan or trailer is attached to the vehicle. The front parking assist will remain active.

Rear-fitted accessories

Particular care must be taken when reversing with rear-fitted accessories e.g. tow-bar or bicycle carrier, as the rear park assist will only indicate the distance from the bumper to the obstacle.

Parking Assist

Rear parking assist

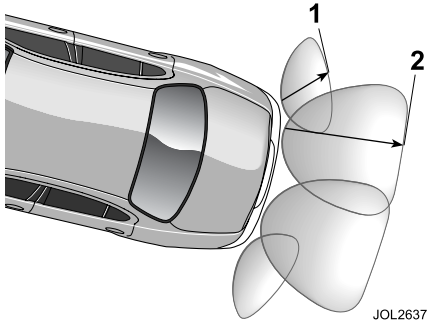

When reverse gear is selected and the ignition is on, rear parking assist provides an audible warning when reversing the vehicle if obstacles are detected within range of the rear of the vehicle, as shown in the illustration above.

- (1) is approximately 300 mm (12 inches).
- (2) is approximately 1500 mm (59 inches).

Front and rear parking assist



When both front and rear parking assist are fitted, a switch is located in the overhead console.

Pressing the switch turns front and rear parking assist on or off together. The integral switch warning light will come on when the system is turned on. The light will blink if a fault is detected in the system.

A switch is not provided where only rear parking assist is fitted.

Note: Front parking assist is always inactive when the ignition is turned on. It is switched on when reverse gear is selected, or if the overhead console switch is pressed at speeds below 15 km/h (9 mph).

Parking Assist

Operation of front parking assist

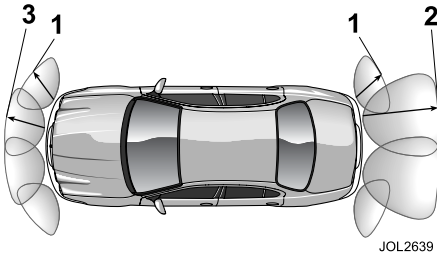

The front parking assist provides an audible warning when driving forwards if objects are detected within range of the front of the vehicle, as shown in the illustration above.

(1) is approximately 300 mm (12 inches).

(2) is approximately 1500 mm (59 inches).

(3) is approximately 800 mm (31 inches).

The front sensors switch off when moving forwards above 15 km/h (9 mph). The system can be switched back on at speeds below 15 km/h (9 mph) by pressing the overhead console switch.

If an obstacle is detected at the front or rear of the vehicle, a series of beeps will be heard from the front or rear speaker respectively, which increases in rate as the vehicle nears the obstacle.

The beep becomes a continuous tone when an obstacle is detected at or within approximately 300 mm (12 inches) from the rear or 250 mm (10 inches) from the front of the vehicle.

Note:

- If the system has a fault when engaging reverse gear or turning on the ignition, then a single three second tone will be heard (only once per ignition cycle) and, if fitted, the switch light will blink. The system is automatically disabled when a fault is detected.
- Front parking assist may sound spurious tones if it detects an ultrasonic frequency using the same band as the sensors.
- Do not overload the vehicle. If the vehicle is overloaded, rear parking assist may sound spurious tones if it detects the road surface.

Horn

HORN LOCATION

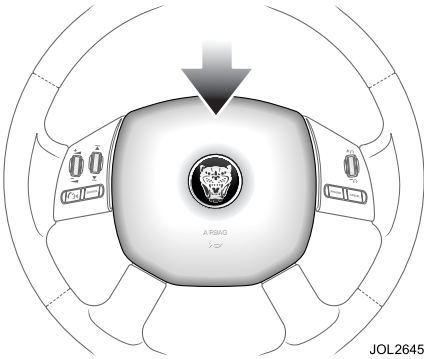

JOL2645

The dual tone horn is operated by pressing the centre pad on the steering wheel.

The horn also operates as a warning horn if the vehicle alarm system is activated.

Sunroof

SUNROOF OPERATION

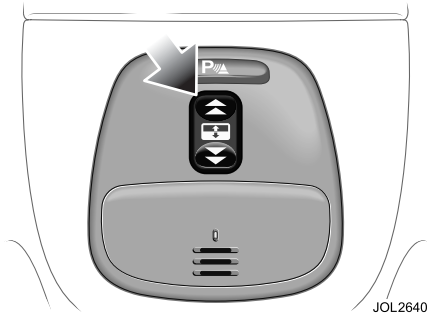

WARNING:

- **Before opening or closing the sunroof check that all occupants are clear.**
- **When leaving the vehicle take the ignition key to prevent misuse of the sunroof switch by remaining occupants, especially children.**

The sunroof switch is located in the overhead console. The ignition switch must be in position **II** for the sunroof to operate.

To open the sunroof

- Push the rear of the switch gently upwards to the first position and hold until the sunroof is fully open. The sunroof can be stopped at any open position by releasing the switch.
- To fully open the sunroof with one-touch operation, briefly push the rear of the switch fully upwards to the second position and then release. To stop the sunroof opening, briefly press the switch upwards, forwards or rearwards.

To close the sunroof

- Push the front of the switch upwards to the first position and hold until the sunroof is closed. It can be stopped at any position by releasing the switch.
- To close the sunroof with one-touch operation, briefly push the front of the switch upwards to the second position and then release. To stop the sunroof closing, press the switch upwards, forwards or rearwards.

To tilt the sunroof

To tilt the sunroof open, push the front of the switch upwards and hold until the required position is reached, or until the tilt is fully open, and then release the switch. To tilt open with one-touch operation, briefly push the switch upwards to the second position.

To close the tilted sunroof, push and hold the rear of the switch until the sunroof is closed. Briefly push the rear of the switch upwards to the second position to tilt closed with one-touch operation.

SUNSHADE OPERATION

The sunshade can be manually opened and closed using the pull cup. When the sunroof is fully open the sunshade is also fully open and, because the pull cup is hidden, it cannot be manually closed from this position.

Note: *If the sunshade is fully open the pull cup cannot be accessed until the sunroof is fully closed.*

Wipers and Washers

WINDSCREEN WIPERS

The windscreen wipers and screen wash functions are controlled by the right-hand column stalk switch and only operate with the ignition in position II.

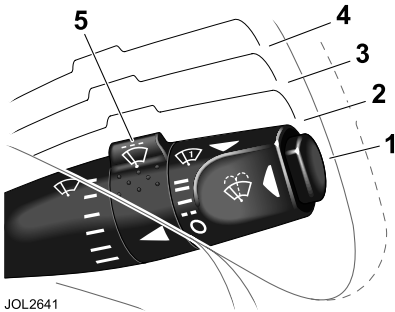

The stalk functions are as follows:

1. Windscreen wipers off and parked.
2. Intermittent wipe.
3. Slow wiper operation.
4. High speed wiper operation.
5. Intermittent wipe delay.

Intermittent wipe

When intermittent wipe is selected the delay between wipes can be varied. Turn the collar (5) to vary the delay from 1 second to 22 seconds.

Flick wipe

Saloon - Pull the column switch towards the steering column for a single wipe. Holding the column switch in this position will operate the wiper continuously at slow speed until released.

Estate - Push the column switch downwards from the OFF position (1). Holding the column switch in this position will operate the wiper continuously at slow speed until released.

Rain sensitive wiper control

When AUTO (turn the rotary collar (5) to AUTO) and intermittent wipe (2) are selected, the wipers will automatically operate when rain falls on to the windscreen, or when moisture is present.

For the wipers to operate, the ignition switch must be in position II.

Note: When starting a journey with a wet windscreen, the rain sensing wipers will not operate immediately the ignition is switched on. Therefore, a flick wipe should be used to clear the windscreen of any moisture.

Caution:

- Ensure that **AUTO** is not selected when entering a car wash or damage to the wiper blades/arms can occur.
- During frosty conditions ensure that **AUTO** is not selected before operating the ignition switch as damage to the wiper blades can occur when the windscreen is frozen.

Wipers and Washers

WINDSCREEN WASH/WIPE

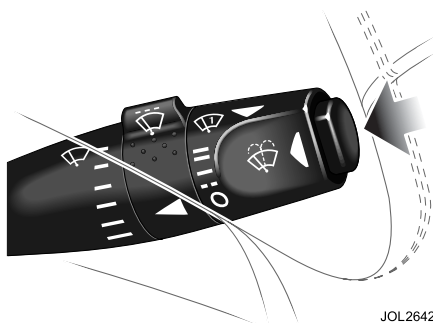

Push the button on the end of the switch to obtain the wash/wipe programme.

If the wipers are set to OFF or intermittent, the washers will operate at slow speed during the washing action when the button is pressed. When the button is released, the wipers will complete three further wipes.

After the wash cycle has been completed the wipers will pause and then complete a drip wipe to clean any remaining drips of moisture from the screen. If rain sensitive wipers are fitted and selected then the wipers will operate until no moisture is detected. Drip wipe can be turned on or off by a Jaguar Dealer/Authorised Repairer, if required.

HEADLIGHT POWERWASH

Note: The headlight powerwash units are mounted between the front headlights.

The headlight powerwash feature will operate if the ignition is in position II and sidelights are switched ON. It will not operate if the washer fluid level is low.

When the windscreen wash/wipe button is pressed, the headlight powerwash directs a short burst at the headlights. If the wash/wipe button is held, the screen wash cycle will continue for up to 20 seconds.

The headlight powerwash will operate the first time the wash/wipe button is pressed and thereafter every sixth succeeding wash/wipe operation. If the headlights or ignition are switched OFF and ON again, headlight powerwash will operate on the next press of the wash/wipe button.

Note: If the washer fluid level is low in the reservoir the windscreen wipers will not operate when windscreen wash is selected even though there may be washer fluid remaining in the reservoir and sprayed onto the screen. This is to prevent damage to the blades, scratching of the glass, or smearing dirt across the screen. Flick wipe can be selected to clear the sprayed fluid from the screen.

Wipers and Washers

ESTATE REAR WASH/WIPE

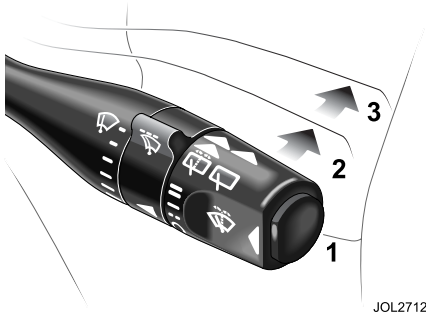

Estate models are fitted with a rear screen wash/wipe. This is operated by the right-hand column stalk and only operates with the ignition in position **II**.

The stalk functions are as follows:

1. Rear wiper off and parked.
2. Intermittent wipe.
3. Continuous wash and wipe.

Push the stalk forward and hold it in position to select position **(3)**. Release the stalk, and it will return to position **(2)**.

If the windscreen wipers are switched on and reverse gear is selected, the rear wiper will wipe intermittently.

If the rear wiper is set to intermittent when reverse gear is selected, the rear wiper will wipe continuously.

Caution: In cold conditions, when frost may be present on the rear screen, it is advisable to switch off the windscreen wipers before selecting reverse gear. The automatic operation of the rear wiper may cause damage to the blade if the screen is heavily frosted.

Handbrake

TO APPLY THE HANDBRAKE

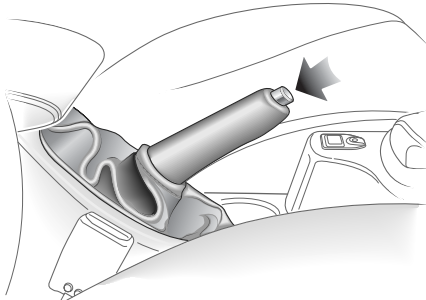

JOL3268

Always apply the handbrake fully before leaving the vehicle.

- Press the footbrake pedal firmly.
- While pressing the brake pedal, pull the handbrake lever up smartly to its fullest extent.
- Do not press the release button while pulling the lever up.
- If your vehicle is parked on a hill and facing uphill, select first gear and turn the steering wheel away from the kerb.
- If your vehicle is parked on a hill and facing downhill, select reverse gear and turn the steering wheel towards the kerb.

Note: Vehicles with automatic transmission should always be left with the selector lever in position **P**.

TO RELEASE THE HANDBRAKE

To release the handbrake, press the brake pedal firmly, pull the lever up slightly, depress the release button and push the lever down.

Interior Features

CUPHOLDERS

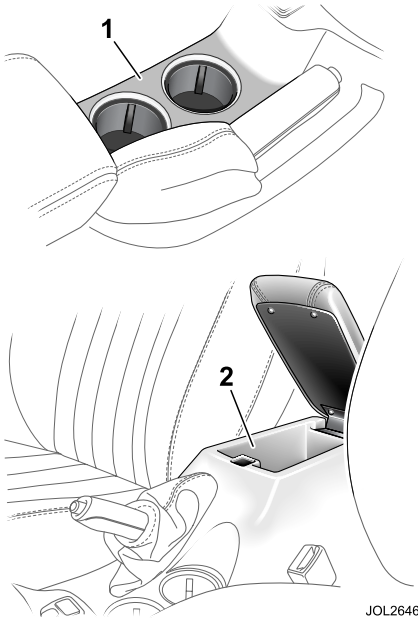

The centre console contains two cupholders (1).



WARNING:

Do not place hot drinks in the cupholders whilst the vehicle is moving; there is a risk of scalding.

Lift the front of the hinged armrest to gain access to the cubby box (2). Where fitted, the cubby box contains a storage rack for audio CDs or cassettes.

GLOVE COMPARTMENT

A glove compartment is located below the passenger's airbag.

To open the glove compartment, lift the handle and allow the lid to drop down. The compartment will be illuminated when open, provided the sidelights are switched on.

If the compartment is left open the light will extinguish approximately 30 minutes after the ignition has been set to position 0.

The glove compartment can be locked using an ignition key.

Light-weight luggage hook

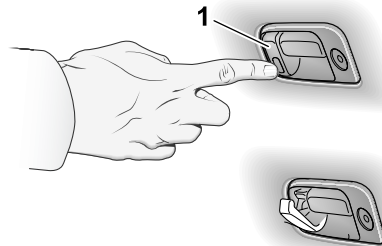

JOL2653

A hook for holding light-weight items such as a handbag, purse or small shopping bag is fitted beside the glove compartment lid release catch. Press the lower part of the hook (1) to lower the hook. Fold the hook back into the lid after use.

Interior Features

SLIDING ARMREST (Where fitted)

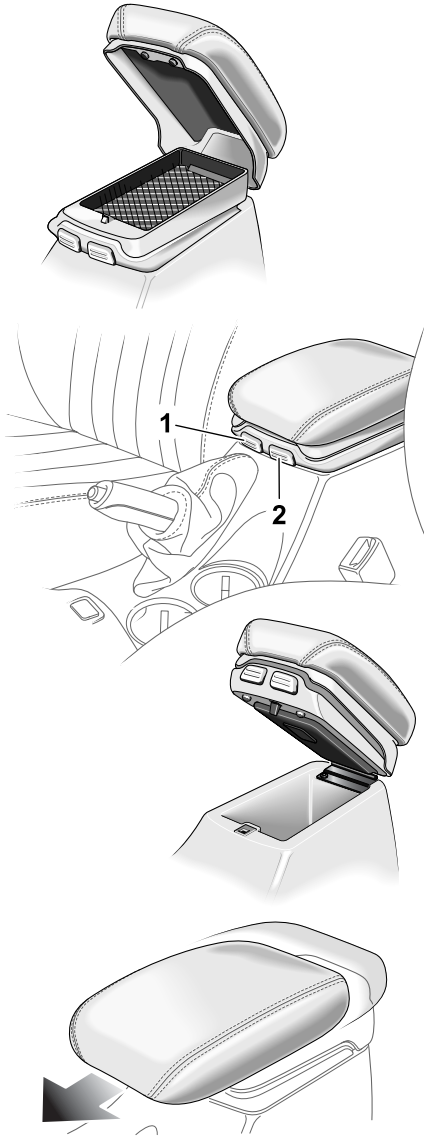

JOL3516

The sliding armrest is hinged at the rear and has two release buttons located on the front of the armrest.

Press the right-hand button (1) and lift the top of the armrest to gain access to the top storage compartment.

Press the left-hand button (2) and lift the complete armrest to gain access to the centre console cubby box compartment. Where fitted, the cubby box contains a storage rack for audio CDs or cassettes.

Pull the top of the armrest forwards or push rearwards to slide the armrest to a comfortable position.

SUN VISORS AND VANITY MIRRORS

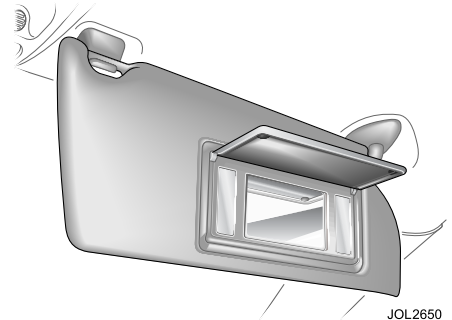

JOL2650

Adjustable sun visors can be swung downwards or unclipped and swung sideways to reduce sun glare.

The sun visors are fitted with illuminated vanity mirrors, behind a hinged flap. The light comes on when the flap is lifted.

Interior Features

CIGAR LIGHTER AND ASHTRAY

(Where fitted)

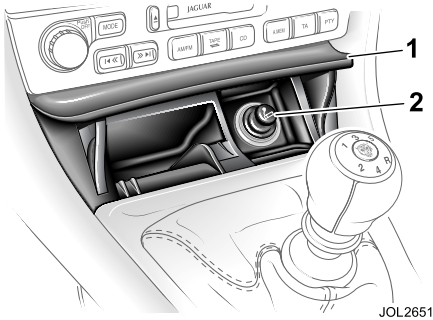

To gain access to the cigar lighter and ashtray, press the lid (1) at the bottom edge, close to the chrome indicator.

To operate the cigar lighter (2) the ignition must be on, press the lighter down and wait until the element has heated, it will then pop-up.

Note: Never hold the lighter knob down. Do not attempt to remove particles from the heating element as it is self-cleaning.

To empty the ashtray, lift it out vertically and remove. After emptying, push the ashtray into the opening until it snaps back into place.

The cigar lighter is replaced by a 12 volt accessory socket on certain models. The accessory socket can be used to power 12 volt appliances having a maximum current rating of 10 amperes. However, if the engine is not running, this will accelerate battery discharging.

Note: When connecting appliances to the accessory socket, use only connectors suitable for use with SAE standard sockets.

REAR CENTRE ARMREST

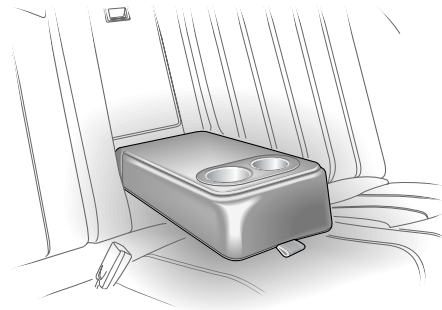

Pull the loop on the rear centre armrest to lower. If not required, raise the armrest to its upright position and push firmly into place. Ensure that the armrest is raised when lowering the seat back to increase the luggage compartment area.



WARNING:

Never carry hot liquids in the cupholder whilst the vehicle is moving. If the contents spill, occupants could be scalded. Use only soft cups and cool liquids.

Engine Starting

AUTOMATIC TRANSMISSION

When the vehicle is stationary the automatic gear selector may be left in **D**, **2**, **3** or **4**, unless the vehicle is to be parked. When stopping for traffic lights, junctions etc., either select **P** or apply the handbrake and select **N**.

MANUAL TRANSMISSION

When the vehicle is stationary it is advisable to apply the handbrake and to move the gear selector to the Neutral position.

BEFORE STARTING

Before starting the engine, new owners/drivers should familiarize themselves with the layout and operation of the controls and instruments.



WARNING:

Before attempting to start the engine, check handbrake is ON and gear selector lever (automatic transmission) is in position P or N or (manual transmission) in Neutral.

STARTING A PETROL ENGINE

The engine cannot be started until the automatic transmission gear selector is in **N** or **P**.

Insert the key into the ignition switch and turn clockwise to position **I** to switch on the ignition.

When the key is turned to position **III** the starter motor will turn the engine until:

- The key is released and automatically returns to position **II**.
- The ignition switch is turned to **0** or **I**.

- The gear selector is moved out of **P** or **N** (automatic transmission vehicles).
- The engine starts.

Do not use the starter continuously for longer than six seconds. Continued use of the starter will discharge the battery and may damage the starter mechanism.

When the engine starts, release the key. Wait until the engine stops turning before re-using the starter.

The red charge warning light in the instrument cluster should go out when the engine is running.

If the engine fails to start

If an ignition key is placed in the ignition switch and turned to position **II** and the alarm security light is flashing, it is possible that the engine will not start. In any event, please contact a Jaguar Dealer/Authorised Repairer to investigate the cause of the light flashing.

It is possible that the fuel system inertia switch may have tripped, see page 157 for the resetting procedure.

If the engine persistently fails to start and flooding is suspected, depress the accelerator pedal fully, hold it in this position and turn the key to position **III** for six seconds. Release the key, remove your foot from the accelerator pedal and then attempt to restart the engine.

Note: *The engine cannot start whilst the pedal is fully depressed, it must be released to enable the engine to start.*

If the engine still fails to start, switch the ignition OFF and contact a Jaguar Dealer/Authorised Repairer.

Engine Starting

Stopping a petrol engine and locking the steering

Turn the key from position **II** to the lock position **0**. This turns off the ignition and stops the engine. The steering will be locked when the key is removed from the switch.

Leaving the key in position **I** or **II** will discharge the battery.

STARTING A DIESEL ENGINE



Insert the key into the ignition switch and turn clockwise to position **II**. Ensure the glow plug indicator light illuminates.

Once the light has extinguished, depress the clutch and do not touch the accelerator pedal. Turn the key to position **III** to turn the starter motor. Continue to operate the starter motor without pausing, until the engine starts. Once the engine has started, release the key, which will return to position **II**.

If the engine stalls or fails to start, the key must be turned to position **I** before attempting to restart.

At extremely low temperatures it may be necessary to crank the engine for up to 30 seconds. If these weather conditions persist, an engine block heater is recommended.

Caution: Do not let the engine run under full load immediately after starting. Give the lubricating oil time to reach the oiling points to prevent damage to the engine.

Stopping a diesel engine and locking the steering

Release the accelerator pedal. Wait until the engine has reached idle speed, then turn the key from position **II** to the lock position **0**. This will turn off the engine. The steering will be locked when the key is removed from the switch.

Caution: Do not depress the accelerator pedal. If the engine is switched off at high speed, the turbocharger will continue running after the engine oil pressure has dropped to zero. This will cause premature wear of the turbocharger bearings.

Leaving the key in position **I** or **II** will discharge the battery.

Caution: Especially after driving at high engine speeds for any length of time, it is important to let the engine run for a time (1 minute) while stationary before switching it off. This allows the turbocharger turbine blades to cool off, while lubrication is still being fed to the turbocharger bearings.

Transmission

AUTOMATIC TRANSMISSION

J-Gate

The J-gate gear selector lever is designed to accommodate two different driving techniques as follows:

- Automatic selection - the right-hand side of the selector gate.
- Manual selection - the left-hand side of the selector gate to individually select 4th, 3rd, or 2nd gear.

Gearshift Interlock

(automatic transmission only)

A brake pedal/gearshift interlock system is incorporated in the automatic gear selector mechanism.

To move the gear selector from Park:

1. Turn the ignition key to position **II** or start the engine.
2. Press the brake pedal.

Gear Selector Positions

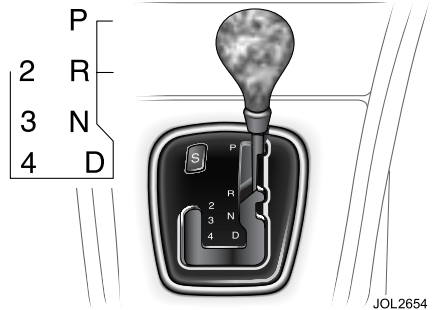

JOL2654



WARNING:

The handbrake or brake pedal must be applied before selecting forward or reverse drive from a stationary position.

P = Park - Use when parking. In this position the transmission is locked. Do not select if the vehicle is moving.

N = Neutral - Disconnects the driveline from the engine. Use the handbrake when stopping temporarily.

R = Reverse - Do not select if the vehicle is moving forward.

The reversing lights come ON automatically when reverse gear is selected and the ignition switch is in position **II**.

D = Drive - All five gears are changed automatically as required by the throttle position and road speed.

2, 3, 4 = Second, third, fourth - If selected, the transmission operates automatically but will not engage gears higher than the one selected.

Transmission

Note:

- After selecting forward or reverse drive ranges from Neutral or Park, wait briefly for the transmission to engage before accelerating.
- When in **Neutral** or **Park** the engine can only be accelerated to:
 - All diesel engines to 3000 rpm with clutch depressed.
 - All automatic transmission vehicles can be revved to the red line.
 - All manual transmission vehicles can be revved to the red line.

Drive to fourth

When driving in gear position **D** with fifth gear engaged, the gear selector can be shifted sideways across the gate to **4**. Provided that the vehicle's speed is not too great, the transmission will shift down to fourth. Fifth will be inhibited until the gear selector is moved back to **D**.

Hill climbing and engine braking

When driving on roads with long downhill gradients, selecting **3** or **2** (depending on road/traffic conditions) will give engine braking.

When the gear selector is moved from **D**, **4** or **3** down to **2**, downshift to second gear will only take place at road speeds below 64 km/h (40 mph).

Shift inhibit

Reverse is inhibited when the vehicle is moving forward at speeds above 8 km/h (5 mph).

Note: Reverse inhibit will not function in limp-home mode.

Kickdown

Kickdown is operated when the accelerator pedal is pressed fully down, beyond the normal operating spring pressure, to provide maximum engine performance. Kickdown is used in circumstances where rapid acceleration is required, such as when overtaking.

Kickdown causes the transmission to change down to the lowest gear possible to achieve maximum acceleration. The gear engaged depends on the road speed at the time of kickdown.

As well as shifting down, the gearshift points are extended to give greater performance. This mode is in effect for as long as the pedal is fully pressed down.

Limp-home mode

In the unlikely event of an electrical or mechanical failure, transmission operation will be impaired. The vehicle gear selector ranges **P**, **R**, **N**, **D** can still be used to enable the vehicle to be driven to a safe area.

The driver should be aware that the vehicle's performance will be reduced and must take this into account when driving. In this event consult a Jaguar Dealer/Authorised Repairer **immediately**.

Transmission

Sport Mode

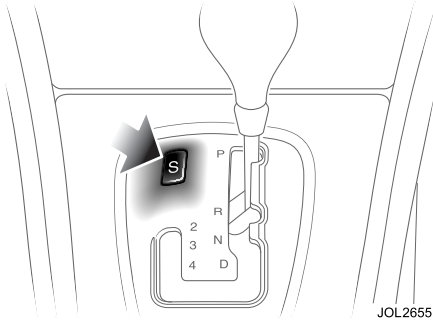

The switch marked **S** on the J-gate surround enables the driver to select either normal **N** or sport **S** modes.

When sport mode is selected the automatic transmission will operate normally, but the gearshift points are extended to make full use of the engine's power reserves.

To select Sport, press the switch. A red light within the switch is illuminated to indicate that sport mode has been selected.

To cancel Sport, press the switch again.

Note: Both sides of the J-gate can be used irrespective of the transmission mode, e.g. with **S** selected the transmission can be operated in full automatic or by manual selection.

In addition to the switched transmission modes (**N** and **S**) the transmission control module will select shift patterns to suit specific conditions.

Cruise Control - When cruise control is operating at set speed the transmission selects a shift pattern to suit cruise control operation.

DSC/Traction control - When DSC/traction control is switched ON and the system is activated, the transmission selects a shift pattern to suit traction control conditions.

Gradients - When the vehicle is being driven on roads with uphill gradients, the transmission adapts the shift pattern to make better use of engine power and aid engine cooling.

Note: Under the conditions described above, the relevant transmission mode will override the **N** or **S** modes selected by the driver. When such conditions no longer exist, e.g. Cruise Control switched OFF, the transmission will revert to the shift pattern previously selected by the driver, i.e. **N** or **S**.

Transmission

MANUAL TRANSMISSION

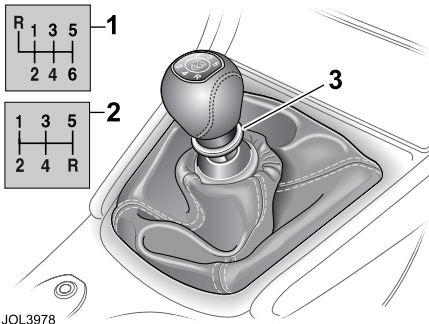

A diagram of the gearshift pattern, either 6 speed **(1)** or 5 speed **(2)** is set in the top of the lever knob.

Depress the clutch pedal completely when changing gear. To avoid excessive clutch wear do not drive with your foot resting on the clutch pedal.

To select reverse gear, pull up the ring **(3)** below the gear knob, then move the lever to the reverse position.

Caution: Do not select reverse gear while the vehicle is moving forwards.

Braking System

ANTI-LOCK BRAKING SYSTEM (ABS)

This system helps to prevent the road wheels from locking and skidding during emergency braking, assisting the driver to maintain full steering and directional stability.

The factor controlling ultimate stopping distance and cornering ability is tyre/road adhesion.



WARNING:

- **It remains the driver's responsibility to drive safely according to prevailing conditions.**
- **The fact that a vehicle is fitted with ABS must never allow the driver to be tempted into taking risks which could affect his/her safety or that of other road users.**
- **The addition of ABS cannot overcome the consequences of trying to stop in too short a distance, cornering at too high a speed, or the risk of aquaplaning.**
- **The driver should always take road conditions into account. A slippery road surface always requires more braking distance for a given speed, even with ABS. A possible increase in stopping distance compared to locked wheels may occur during ABS operation on slushy snow, gravel, sand, or some heavily corrugated or ridged warning sections of road surfaces.**

ABS optimises tyre/road adhesion under maximum braking conditions though it cannot provide increased cornering ability. There is no need for special braking techniques, such as pumping the brakes, to achieve optimum braking distances and control on poor or slippery road surfaces. Tyres must be in good condition to achieve maximum adhesion.

During normal braking the ABS will not be activated. However, if the braking force applied begins to exceed tyre/road adhesion the ABS will automatically activate, preventing the road wheels from locking.

In these circumstances a pulsating effect will be felt from the brake pedal indicating that the system is functioning. The pulsating effect is due to small fluctuations in pressure supplied to the brakes by the system to maintain full tyre/road adhesion.

Under severe braking on some road surfaces tyre noise may be apparent even though the wheels will at no time become locked.

ABS monitoring

The ABS control module monitors the ABS electrical system from ignition switch ON to ignition switch OFF. Any malfunction will be indicated by the anti-lock warning light coming on.

Should a fault develop in the ABS system, the brake system will still operate conventionally and with the same standard of performance as vehicles not equipped with ABS.

Braking System

Caution: Consult a Jaguar Dealer/ Authorised Repairer immediately if the warning light comes on while driving, a system failure is indicated.

Advice on ABS braking techniques

For optimum ABS performance these instructions on braking techniques during ABS operation should be followed:

- Do not release brake pressure when the pulsating effect is felt. Maintain a constant pressure until the manoeuvre is completed.
- To familiarise yourself with the feel of the brake pedal during ABS braking, practise an emergency stop procedure, always making sure it is safe to do so. With the seat belts fitted to all occupants, drive the vehicle at 32 km/h (20 mph) and brake sharply.
- ABS enables the driver to steer around obstacles during emergency braking. However, the consequences of turning sharply at high speed cannot be overcome by the ABS.
- Do not attempt to pump the brakes to avoid skidding as this can interfere with the ABS operation. The ABS will not allow the wheels to skid under normal road conditions.
- The ABS will tend to keep the vehicle straight during braking. Because braking distances may increase under certain road conditions, it is necessary to plan and make turning manoeuvres as early as possible.

EMERGENCY BRAKE ASSIST

The emergency brake assist (EBA) system is only available on vehicles fitted with dynamic stability control (DSC). The EBA system measures the rate at which the brake pressure increases. If the system detects an emergency braking situation, EBA automatically initiates the full braking effect. This can reduce stopping distances in critical situations, which can help an inexperienced driver to stop in the same distance as an experienced driver.



WARNING:

The EBA system is an additional safety system: it is not intended to relieve the driver of his responsibility for exercising due care and attention when driving.

Traction Control

TRACTION CONTROL OPERATION



JOL2657

2.0 litre petrol and all diesel-engine vehicles are fitted with traction control as standard. The system will intervene to prevent wheel spin, by automatically reducing the power output from the engine and applying braking to individual wheels.

This improves acceleration, particularly on surfaces with uneven friction, for example, one wheel on ice the other on tarmac.

Traction control is always switched ON when the engine is started.

If the system is operating, the warning light in the instrument cluster will flash.

The traction control (and dynamic stability control, when fitted) system can be switched OFF by pressing the switch on the gear selector surround. The warning light in the instrument cluster will remain on and a message will be shown to indicate that the system has been switched OFF. If the switch is pressed again the system will switch ON.

Note: If cruise control is engaged it will automatically disengage if traction control activates.

If a message centre is fitted, a system malfunction is indicated by the message:

TRACTION CONTROL FAULT

Warning light: **Amber.**

For all vehicles, the instrument cluster warning light will be lit.

It is safe to drive the vehicle but the system may not activate under wheel spin or slide conditions. Report the fault to a Jaguar Dealer/Authorised Repairer as soon as possible.



WARNING:

- **The fact that the vehicle is fitted with Traction Control must never allow the driver to be tempted into taking risks which could affect his/her safety or that of other road users. In all cases it remains the driver's responsibility to drive safely according to the prevailing conditions.**
- **It is recommended that, if using snow chains, traction control should be switched OFF.**

When traction control is switched ON and the system is activated, the transmission selects a shift pattern to suit traction control conditions.

Stability Control

DYNAMIC STABILITY CONTROL (DSC)



Dynamic stability control is operational whenever the engine is running, unless it has been switched off. If the system is operating, the warning light in the instrument cluster will flash.

The DSC system controls the anti-lock braking system (ABS), traction control and yaw control of the vehicle.

Yaw control determines the vehicle's direction relative to the driver's inputs (sideslip and under/oversteer). It applies braking pressure to individual wheels if excessive variation is detected. This ensures that the vehicle follows the driver's intended direction of travel.

The system will intervene to prevent wheel spin, by automatically reducing the power output from the engine and applying braking to individual wheels.

This improves acceleration, particularly on surfaces with uneven friction, for example, one wheel on ice the other on tarmac.

The dynamic stability control system can be switched OFF by pressing the switch on the centre console. The warning light in the instrument cluster will remain on and, if fitted, a message will be shown to indicate that the system has been switched OFF. If the switch is pressed again the system will switch ON.

Note: *If cruise control is engaged it will automatically disengage if stability control activates.*

If a message centre is fitted, a system malfunction is indicated by the message:

STABILITY CONTROL FAULT

Warning light: **Amber.**

For all vehicles, the instrument cluster warning light will be lit.

It is safe to drive the vehicle but the system may not activate under wheel spin or slide conditions. Report the fault to a Jaguar Dealer/Authorised Repairer as soon as possible.



WARNING:

- **The fact that the vehicle is fitted with Dynamic Stability Control must never allow the driver to be tempted into taking risks which could affect his/her safety or that of other road users. In all cases it remains the driver's responsibility to drive safely according to the prevailing conditions.**
- **It is recommended that when using snow chains, DSC should be switched OFF.**

When DSC is switched ON and the system is activated, the transmission selects a shift pattern to suit traction control conditions.

Driving Information

BEFORE DEPARTING



WARNING:

Ensure the handbrake is on and the gear selector is in position P or N before attempting to start the engine.

Before driving off, check the gauges and warning lights and messages. Take special note of any warning light that is on.

Seat belts are provided for your safety and it is unwise, and in certain countries illegal, to commence any journey, however short, without wearing them.

WARMING UP

Do not operate the engine at high speed when first started but allow time for the engine to warm up and the oil to circulate.

ENGINE BRAKING

When driving on mountain roads with long downhill gradients it is advisable to select a low gear.

HEADLIGHTS IN DAYLIGHT

When visibility is poor the headlights with dipped beam setting should be switched on so that the vehicle may be seen more easily by other road users. The instrument illumination dimmer control adjusts the brightness of the panel lighting.

PARKING THE VEHICLE

When leaving the vehicle, remember the following:

- Whenever the vehicle is being parked apply the handbrake. If your vehicle is fitted with automatic transmission, move the gear selector to Park **P**.
- Do not leave children or pets in the vehicle unattended.
- Do not leave luggage or valuables on view. Always take your valuables with you or lock them in the luggage compartment.
- Remove the ignition key and spare keys, even when the vehicle is in your garage.
- When the vehicle is unoccupied, close all windows and lock all doors securely.
- Park the vehicle where it can be seen. At night, park in a well-lit area.
- When leaving the vehicle unattended, for maximum security ensure that the doors are double-locked.
- Ensure that the keys are removed from the vehicle before locking the doors, and that all doors, the luggage compartment and the bonnet are closed.

Driving Information

ENGINE OIL CONSUMPTION

A certain amount of oil consumption is normal. The rate of consumption will depend on the following:

- The quality and viscosity of the oil.
- The amount of oxidation and dilution of the oil.
- Climatic conditions.
- The speed at which the engine is being operated.
- Road conditions.

Drivers should expect above normal consumption when the engine is new, and after running-in if high speeds are sustained.

WINTER DRIVING

Freeing a frozen door lock

Caution: Do not apply a proprietary lock de-icer through the keyhole.

Should the lock become frozen, warm the end of the key before use.

Windscreen wiper blades

Before driving away, clear any ice from the windscreen and check that the wiper blades are free. Switching on the heated screen will accelerate this process.

Frost precautions

The correct concentration of coolant must be maintained at all times when replenishing or refilling the cooling system.

TOURING

Foreign travel

Before planning foreign travel, check with a motoring organisation to ensure that your vehicle will comply with legal requirements of the countries you intend to visit.

It is advisable to carry vital spare parts to ensure serviceability in a remote area.

International motoring organisations are helpful for all aspects of long distance touring advice.

In some countries it is a legal requirement to carry spare vehicle bulbs.

First aid kit

A first aid kit is compulsory equipment in certain countries. Your Jaguar Dealer/Authorised Repairer can supply a first aid kit.

Fire extinguishers

Many countries make it compulsory to carry a fire extinguisher. Your Jaguar Dealer/Authorised Repairer can supply and fit one (see page 182).

Fuel in containers

Some countries forbid the carrying of fuel in containers, as do most ferry and hovercraft operators.

Cellular radio telephones

Ask your motoring organisation about the use of cellular radio telephones before travelling abroad, as some countries exercise controls on the importation and use of such equipment.

Driving Information

Roof-rack

For Saloon models, only the Jaguar approved roof-rack should be used.

For Estate models, an approved load carrier must be attached to the roof rails, before attempting to carry items on the roof. Do not attempt to attach loads directly to the roof rails.

The maximum load, including the weight of the roof rack or load carrier, must not exceed the load rating indicated on the roof-rack bars and **must** be deducted from the vehicle maximum luggage load. Do not exceed the roof load capacity (refer to page 211).

When carrying items on the roof, make sure the load is distributed evenly. It is advisable to place heavier items as low in the vehicle as possible. Make sure items placed on the roof do not obstruct the sunroof or prevent the Estate tailgate from opening.

Always ensure that items are securely fastened to the roof-rack or load carrier, to avoid the load from shifting.

Loads on the roof-rack may affect vehicle handling, especially in crosswinds or when cornering. Where possible, avoid heavy braking and sudden acceleration.

Jaguar warning triangle

A warning triangle to give traffic advanced notice of a disabled vehicle is compulsory in many countries. A triangle, designed to international standards, is standard equipment in certain countries.

Hazard warning lights must be used with the warning triangle.

The warning triangle with its stand legs folded flat, is mounted on the inside of the luggage compartment lid (Saloon) or under the luggage compartment floor (Estate).

In an emergency, remove the triangle and unfold its stand legs. Place the triangle in the road in accordance with local traffic regulations to give oncoming traffic warning of an immobilised vehicle.

TOWING A CARAVAN OR TRAILER

Your Jaguar Dealer/Authorised Repairer, and the main motoring and caravanning organisations can advise you on towing, towing weight capacities and about regulations that apply in other countries.

The following are important points of safety, stability and comfort upon which further advice should be sought:

- Maximum braked towing weight is permissible, provided long periods of uphill driving on gradients over 8% are not undertaken.
- In high altitude mountainous regions, the thinner atmosphere can reduce engine performance. Above 1000 metres (3280 feet) the stipulated maximum permitted gross train weight must be reduced by 10% for every 1000 metres (3280 feet) in altitude.

Driving Information

- The kerbside weight of the vehicle can be found from page 208.
- When towing, the nose weight of the caravan or trailer and the tow-bar assembly must be deducted from the permissible maximum load (see page 208).
- When towing at the maximum permissible rear axle load keep within legal towing speeds but in any case do not exceed 100 km/h (62 mph). Increase tyre pressures to 250 kPa (39 lbf/in², 2.5 bar, 2.55 kg/cm²).
- The recommended maximum tow-ball nose weight is shown on page 211. Having a lower nose weight or exceeding the maximum nose weight limit may impair the vehicle's handling.
- It is essential that only a Jaguar tow-bar and Jaguar electrical tow-bar kit are supplied and fitted by a Jaguar Dealer/Authorised Repairer.
- Ensure that the towing vehicle's engine, transmission, suspension, brakes and tyres are fully efficient and regularly serviced. Similarly check the wheels, tyres, brakes and wheel bearings of the caravan or trailer.
- Adjust the headlight level to avoid dazzling other road users.

2.0 litre petrol and diesel models

After towing a caravan or trailer in a 1st or 2nd gear hill climb for extended periods, in ambient temperatures above 25°C (77°F), allow the car to idle for five minutes before switching the engine off. This will aid engine cooling.

Caution:

- 1. Using electrical kits not specifically designed for this Jaguar will damage the electrical system of the vehicle.**
 - 2. When not in use, it is recommended that the removable tow-ball is either securely stowed in the luggage compartment or, preferably, not in the vehicle. Do not leave it loose in the vehicle.**
- Avoid heavy braking. As the overrun brake on the caravan or trailer is not connected to the ABS, heavy caravan or trailer braking could critically affect the stability of the outfit as a whole.

Driving Information

TOW-BAR FIXING POINTS - SALOON

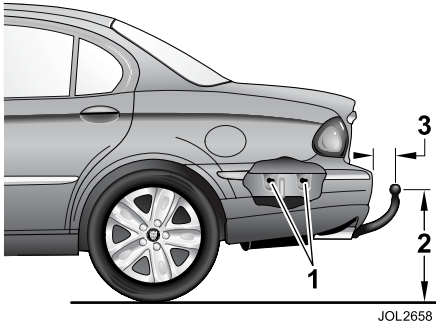

The rear longitudinal members are factory pre-marked (1) for drilling for tow-bar mountings. There are three mounting points on each side.

There is a depression in the lower back panel which marks the point at which a hole is to be drilled for the wiring harness.

Tow-ball centre height from the ground at Gross Vehicle Weight (GVW):

(2) = 385 mm (15.2 inches).

Tow-ball centre distance from bumper cover:

(3) = 76 mm (3 inches).

TOW-BAR FIXING POINTS - ESTATE

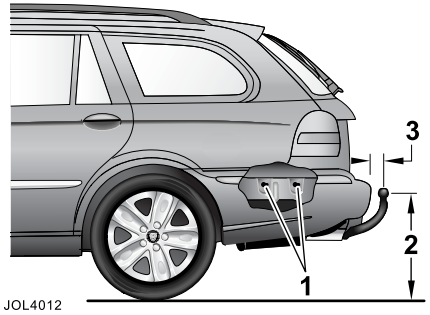

The rear longitudinal members are factory pre-marked (1) for drilling the tow-bar mountings. There are three mounting points on each side.

There is a depression in the lower back panel which marks the point at which a hole is to be drilled for the wiring harness.

Tow-ball centre height from the ground at Gross Vehicle Weight (GVW):

(2) = 350 mm (13.75 inches).

Tow-ball centre distance from bumper cover:

(3) = 95 mm (3.75 inches).

Fuel and Refuelling

SAFETY PRECAUTIONS

Before refuelling, switch off the ignition and remove the key.

Note: Do not leave the ignition key in the vehicle; vehicles have been stolen from garage service/filling stations whilst the driver is absent from the vehicle. It is recommended that the vehicle is locked, if left unattended.

Caution: Do not put additives of any kind (fuel or oil) in the fuel tank. Additives could reduce engine life or affect exhaust emissions.



WARNING:

- Fuel vapour is highly flammable and in confined spaces is explosive and toxic. In the event of inadvertent spillage, and before refuelling, always switch OFF the engine. Do not use exposed flame or light. Do not smoke. Do not inhale fumes.
- Do not fill the tank so that fuel is visible in the fuel filler intake tube. This could cause spillage and danger from exposed fuel.

FUEL TANK FILLING

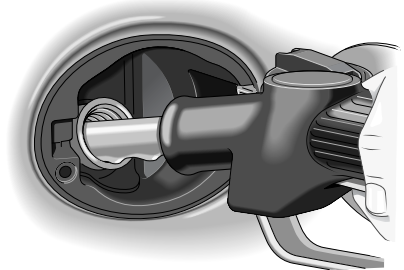
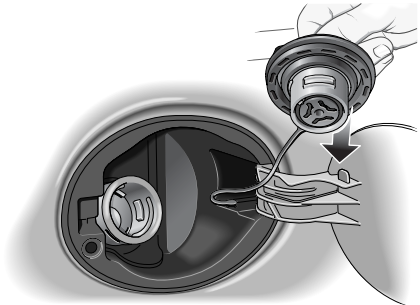
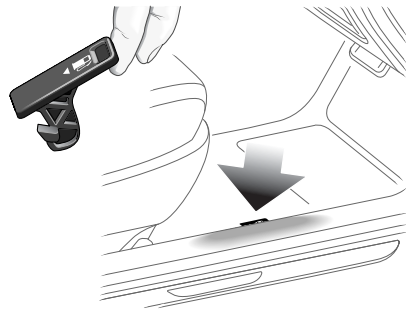

JOL2989

The fuel filler flap release is located on the floor, outboard of the driver's seat. The filler flap is on the right-hand side of the vehicle. Pull the lever to release the flap.

Note: Vehicles with a diesel engine have a **yellow** filler cap.

Fuel and Refuelling

To remove the filler cap, turn it anti-clockwise approximately $\frac{1}{2}$ a turn, until a slight resistance is met. Continue to turn the cap a further $\frac{1}{4}$ turn and remove it from the filler neck.

If the vehicle is fitted with a diesel engine, a label on the inside of the fuel filler flap serves as a reminder to fill the tank with the correct fuel.

The cap, which is held by a retaining strap, can be stowed over the hook on the flap to allow easy access to fill the tank.

When filling, the dispenser nozzle must be inserted into the filler neck sufficiently to open the trap door for fuel to flow into the fuel tank. For quickness and to completely fill the tank, ensure that the fuel nozzle rests on the bottom of the filler neck as shown. Fill the tank until the filler nozzle automatically shuts off. Filling beyond this point could result in fuel spillage.

After refuelling, refit the filler cap in the filler neck and twist the cap clockwise until it clicks three times. Close the flap, which automatically locks shut.

The continuous use of high quality fuel makes the need for additional additives unnecessary. This will help to protect the engine components against corrosion, carbon deposit formation and prevent the fuel injection system from clogging.

If in doubt your local Jaguar Dealer/ Authorised Repairer will advise on which fuel must be used in your vehicle.

Emission control components

Owing to the legislative requirements or options available in some countries, a Jaguar Dealer/Authorised Repairer should be consulted where any doubt exists as to the precise emission control system specification of this vehicle.

FUEL CAPACITY

Avoid the risk of running out of fuel and never intentionally drive the car when the fuel gauge indicates that the tank is empty. When refuelling your vehicle after the fuel gauge reads empty, you may not be able to add the fuel quantity shown below as there will be a small reserve remaining in the tank.

Total tank capacity	61.5 litres (13.5 Imp. Gallons)
Indicated refill capacity - E to F on fuel gauge	56.5 litres (12.4 Imp. Gallons)
Unindicated (reserve) capacity	5.0 litres (1.1 Imp. Gallons)

Fuel and Refuelling

FUEL REQUIREMENTS - PETROL ENGINES

Caution: Vehicles with petrol engines must only be filled with Unleaded Fuel. Leaded fuel will damage the catalytic converters.

Unleaded fuel

All vehicles are fitted with a catalytic system and can only use unleaded fuel.

Unleaded fuel must be used for the emission control system to operate properly. Its use will also reduce spark plug fouling, exhaust system corrosion and engine oil deterioration.

The preferred fuel should have an octane rating of at least 95 RON (Research Octane Number).

Super Green Plus 98 RON unleaded fuel (where available) may be used as an alternative to the standard 95 RON unleaded fuel.

Some countries have only 91 RON fuel available. The vehicles in these countries are specially calibrated to use this fuel.

Using unleaded fuel with an octane rating lower than recommended can cause persistent, heavy spark knock (a metallic rapping noise). If severe, this can lead to engine damage.

If a heavy spark knock is detected even when using fuel of the recommended octane rating, or if you hear steady spark knock while holding a steady speed on level roads consult a Jaguar Dealer/ Authorised Repairer to have the problem corrected. Failure to do so is misuse of the vehicle, for which Jaguar Cars Limited is not responsible. However, occasional light spark knock for a short time while accelerating or driving up hill, may occur.

Fuels containing alcohol

Caution: Take care not to spill fuel during refuelling. Fuel containing alcohol can cause paint damage, which may not be covered under the warranty.

Some fuel suppliers sell fuel containing alcohol without advertising its presence. Where uncertainty exists check with the service station operator.

Note: *Some difficulty in starting may be encountered when using alcohol blended fuel.*

Ethanol

Caution: This vehicle is not suitable for use with fuels containing more than 10% ethanol. Do not use E85 fuels (85% ethanol content). Equipment necessary for the use of fuels containing more than 10% ethanol is not fitted to this vehicle. If E85 fuels are used, serious engine and fuel system damage will occur.

Fuels containing up to 10% ethanol (grain alcohol) may be used. Ensure the fuel has octane ratings no lower than those recommended for unleaded fuel. Most drivers will not notice any operating difference with fuel containing ethanol. If a difference is detected, the use of conventional unleaded fuel should be resumed.

Methanol

Some fuels contain methanol (methyl or wood alcohol). If you use fuels containing methanol the fuels must also contain co-solvents and corrosion inhibitors for methanol. Also, do not use fuels that contain more than three per cent methanol even if they contain co-solvents

Fuel and Refuelling

and corrosion inhibitors. Fuel system damage or vehicle performance problems resulting from the use of such fuels is not the responsibility of Jaguar Cars Limited, and may not be covered under the warranty.

Methyl Tertiary Butyl Ether (MTBE)

Unleaded fuel containing an oxygenate known as MTBE can be used provided the ratio of MTBE to conventional fuel does not exceed 15 per cent.

MTBE is an ether based compound, derived from petroleum, which has been specified by several refiners as the substance to enhance the octane rating of fuel.

Reformulated gasoline

Several petroleum companies have announced the availability of reformulated fuels. These fuels are specially designed to further reduce vehicle emissions.

Jaguar fully supports all efforts to protect and maintain ambient air quality and encourages the use of reformulated gasoline where available.

FUEL REQUIREMENTS - DIESEL ENGINES

Use only high quality diesel fuel according to specification EN 590 or equivalent.

Caution: If you inadvertently fill your vehicle with petrol instead of diesel, do not attempt to start the engine.

Contact your Jaguar Dealer/ Authorised Repairer immediately.

Attempting to start the engine with petrol in the fuel tank will cause extensive damage to the engine and fuel system, which will not be covered by your Jaguar warranty.

Jaguar can accept no responsibility for any damage caused by running your vehicle with petrol in the fuel tank.

Prolonged use of additives is not recommended. Do not add kerosene/ paraffin or petrol to diesel fuels.

Caution:

- **Do not use RME (bio diesel) except in the case of those proprietary diesel fuels which contain a mix of up to 5%. Jaguar can accept no responsibility for damage caused by using RME in concentrations greater than 5%.**
- **Do not use vegetable oil instead of diesel. Jaguar can accept no responsibility for damage caused by using vegetable oil at any concentration.**

Fuel and Refuelling

DIESEL PARTICLE FILTER (DIESEL MODELS ONLY)

Diesel vehicles are fitted with a Diesel Particle Filter (DPF) which results in additional effective exhaust emission purification. When the engine is at its normal operating temperature and the vehicle is driven at moderate speeds, 48 km/h (30 mph), or more, a regeneration of the DPF takes place automatically. This means that the exhaust particles collected in the filter are burned away and the filter is emptied.

Message centre warnings

When DPF regeneration has not been possible due to a long period of unfavourable driving conditions, a warning message **DPF FULL SEE HANDBOOK** plus either a RED or AMBER priority warning light is displayed on the message centre, see page 99.

Caution: If the message with the RED priority warning indicator is displayed, seek qualified assistance as soon as possible before damage to the DPF occurs.

If the message with the AMBER priority warning indicator is displayed, regeneration of the DPF is required.

Note: *Once triggered, the warning light and message will remain on until regeneration has occurred, or the starter switch is turned off. If regeneration of the DPF is still required when the starter switch is turned back on, the warning light and message will only reappear after approximately four minutes of driving.*

To carry out DPF regeneration

- To start regeneration of the DPF, drive the vehicle until the engine reaches its normal operating temperature.
- The vehicle must then be driven for a least 20 minutes at a speed of 48 km/h (30 mph) or more, even if the amber warning indicator extinguishes after a short time of driving.
- Successful regeneration of the DPF is indicated by the warning message and AMBER priority warning light being extinguished from the message centre.

Caution: If the vehicle is frequently driven for short distances or at speeds below 48 km/h (30 mph) for long periods, especially in cold weather conditions, the engine and exhaust system does not reach normal operating temperatures. This means that the regeneration of the DPF may be required to be carried out occasionally in order to avoid impaired function of the filter.

Note:

- *If the vehicle is exited shortly after regeneration has taken place, heat from the DPF may be felt from underneath the vehicle, especially in cold weather conditions. This is normal.*
- *Because of the high temperature which can occur in the DPF, it is advisable not to park the vehicle where the DPF can come into contact with flammable materials under the vehicle, see page 145.*

Fuel and Refuelling

RUNNING OUT OF FUEL

(Diesel models only)

Vehicles with diesel engines are equipped with a system to prevent the fuel tank from emptying completely. When the fuel reaches a minimum level, the system will activate and simulate a misfire (i.e. the engine will not run properly). Proceed to the next filling station and refuel with at least 4 litres of fuel.

If the symptoms are ignored, the engine will eventually stop, with approximately 4 litres of fuel remaining in the tank (this prevents the fuel system from running dry, which could cause damage to the vehicle).

If the gauge indicates low fuel or the warning light illuminates, the fuel tank should be refilled as soon as possible.

CATALYTIC CONVERTERS AND DIESEL PARTICULATE FILTERS

A few precautions on the use of vehicles fitted with catalytic converters and diesel particulate filter (DPF) are necessary. These are:

- In order to maintain the efficiency of the emission control system it is essential that the correct fuel is used. If the vehicle is fitted with a petrol engine, never refuel with leaded fuel: this will seriously damage the catalytic converters. If the vehicle is fitted with a diesel engine, use only high quality diesel fuel to specification EN 590 or equivalent.
- Heavy impact on the converter and DPF casings must be avoided.

- A correctly tuned engine optimises exhaust emissions, performance and fuel economy. It is recommended that the vehicle is regularly maintained.
- The use of catalytic converters and DPF increases exhaust system temperatures, therefore, do not operate or park the vehicle in areas where combustible materials such as dry grass or leaves may come into contact with the exhaust system.
- The engine settings must not be altered; they have been established to ensure that the vehicle will comply with stringent exhaust emission regulations. Incorrect engine settings could cause unusually high catalytic converter and DPF temperatures and thus result in damage to the converter, DPF and vehicle.

If adjustment to the settings is considered necessary, this should be performed by a Jaguar Dealer/ Authorised Repairer.

- Do not continue to operate the vehicle if any engine malfunction is evident; malfunctions should be rectified immediately. For instance, misfire, loss of engine performance, excessive oil consumption or engine run-on may lead to unusually high catalytic converter temperatures and may result in damage to the converters and vehicle.

Fuel and Refuelling

- Do not run a petrol engine with either a spark plug lead disconnected or a spark plug removed. Do not use any device that requires an insert into a spark plug hole in order to generate air pressure e.g. tyre pump, paint spray attachment etc., as this could also result in catalytic converter damage.
- The vehicle is designed for normal road use. Below are examples of abuse which could damage the catalytic converters and vehicle:
Competition or off-road use.
Excessive engine speed.
Overloading the vehicle.
Switching off the engine whilst in gear.
These may lead to a dangerous condition due to excessively high catalytic converter temperatures.